

The Heavy Flavor Tracker (HFT)

The Silicon Vertex Upgrade of STAR @ RHIC

Spiros Margetis* and the STAR Collaboration

* Kent State University, USA

BEACH 2010, June 21-26, Perugia, Italy

Outline

- The Heavy Flavor physics opportunities in Heavy Ion Collisions
- The Challenges of the ultra-high multiplicity environment
- The HFT concept and realization

The Bottom Line

- Hot and dense (partonic) matter with strong collectivity has been formed in Au+Au collisions at RHIC. Study of the properties of the new form of matter requires more penetrating probes like **heavy** quarks.
 - Mechanism for parton energy loss.
 - Thermalization.
- **New micro-vertex detector is needed for STAR experiment.**
- DOE milestone 2016: “Measure production rates, high pT spectra, and correlations in heavy-ion collisions at $\sqrt{s_{NN}} = 200$ GeV for identified hadrons with **heavy flavor** valence quarks to constrain the mechanism for parton energy loss in the quark-gluon plasma.”

STAR Detector

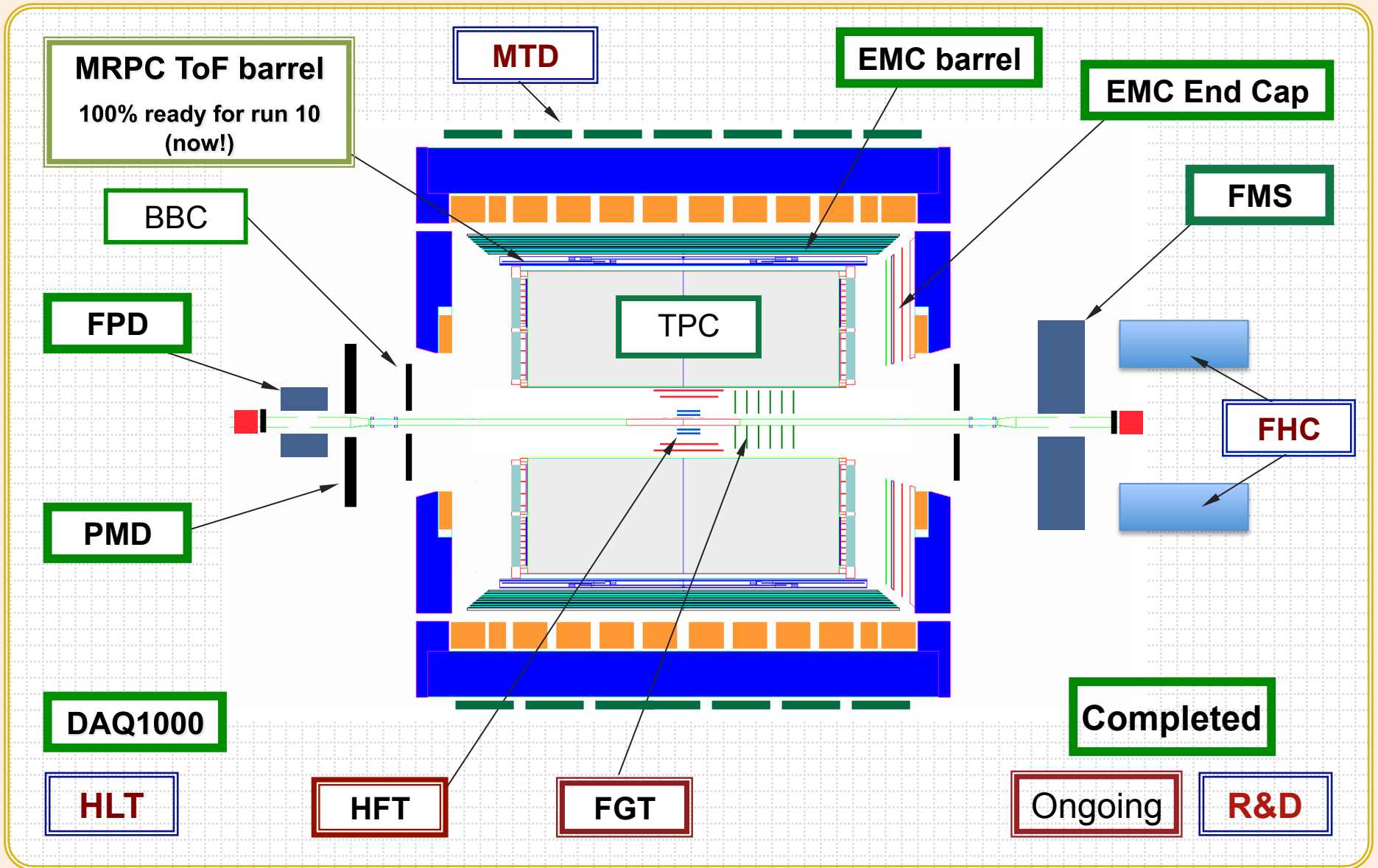

The QCD Phase Diagram and High-Energy Nuclear Collisions

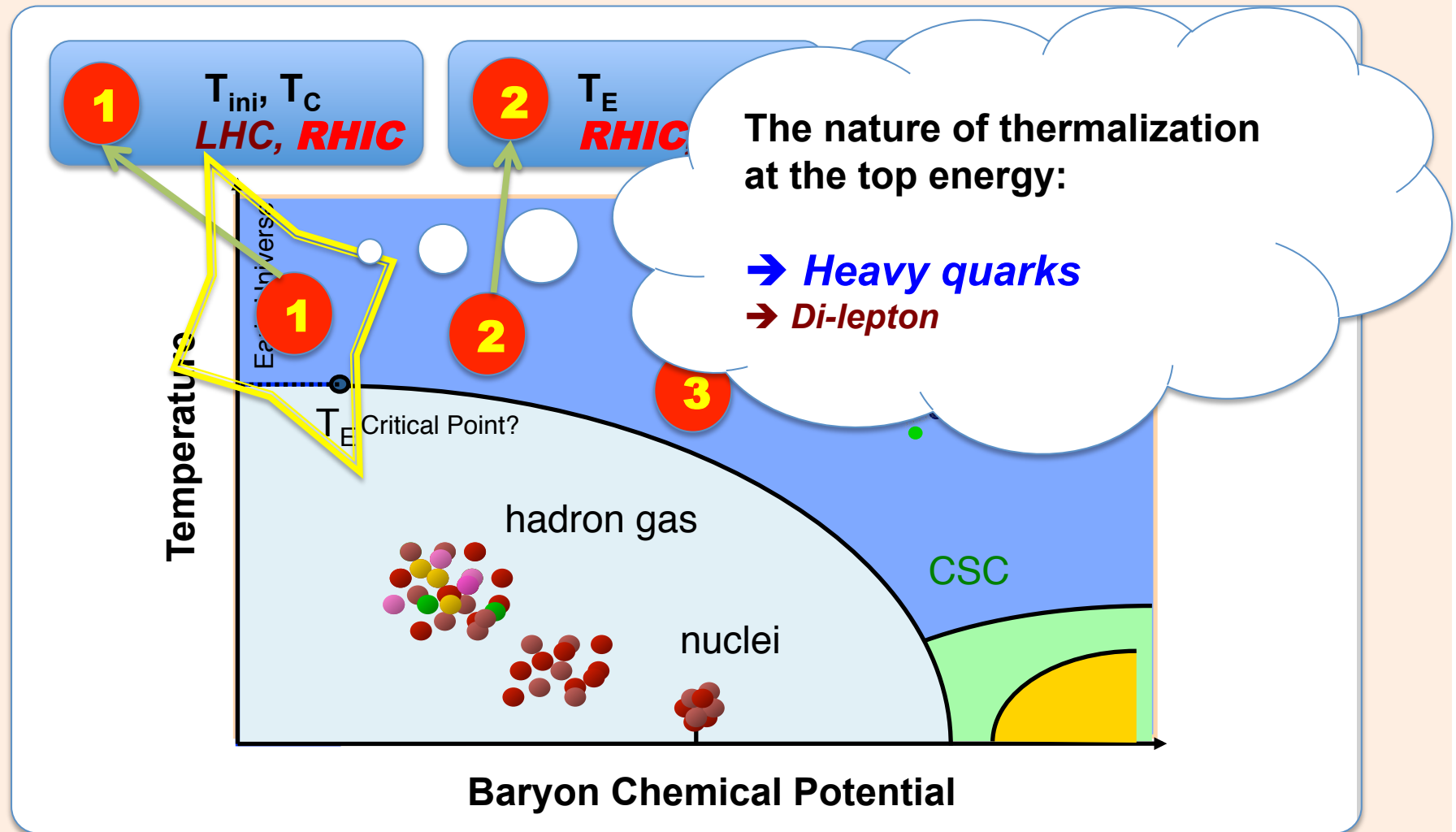

STAR Physics Program

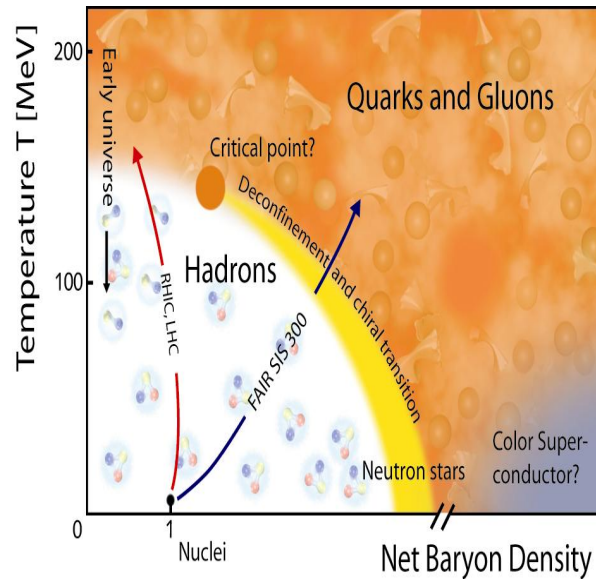

1) At 200 GeV top energy

- Study *medium properties, EoS*
- pQCD in hot and dense medium

2) RHIC beam energy scan

- Search for the *QCD critical point*
- Chiral symmetry restoration

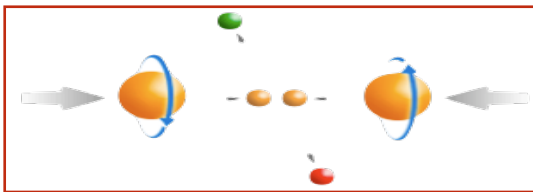

Spin program

- Study *proton intrinsic properties*

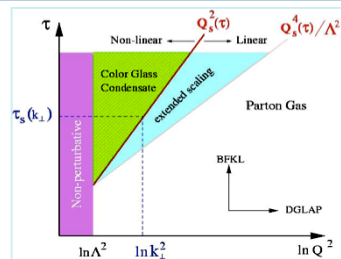

Forward program

- Study low-x properties, search for *CGC*
- Study elastic (inelastic) processes (pp2pp)
- Investigate *gluonic exchanges*

Partonic Energy Loss at RHIC

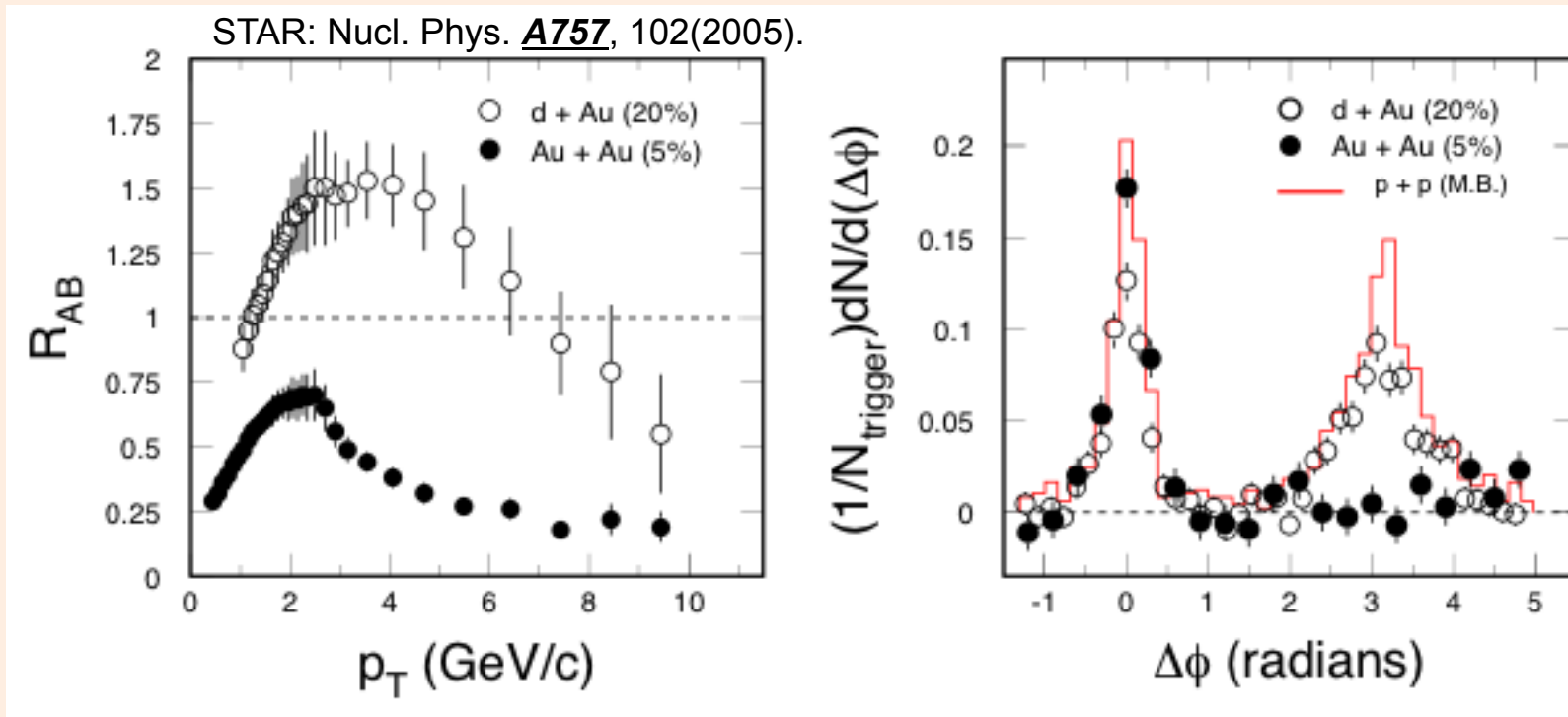

$$R_{AA} = \frac{dN/dp_T^{AA}}{\langle N_{bin}^{AA} \rangle dN/dp_T^{pp}}$$

Central Au+Au collisions: light quark hadrons and the away-side jet in back-to-back 'jets' are suppressed. Different for p+p and d+Au collisions.

Energy density at RHIC: $\epsilon > 5 \text{ GeV/fm}^3 \sim 30\epsilon_0$

Explore pQCD in hot/dense medium
 $R_{AA}(c,b)$ measurements are needed!

Heavy Quark Energy Loss

STAR: Phys. Rev. Lett, **98**, 192301(2007).

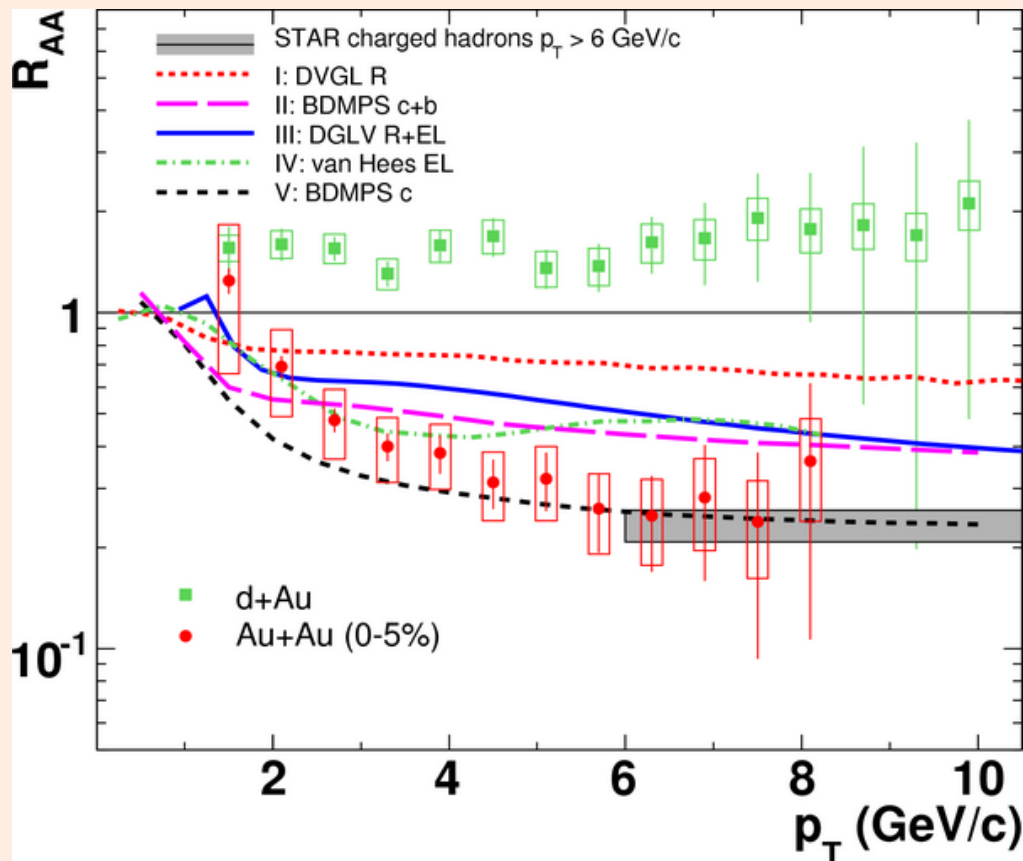

1) Non-photonic electrons decayed from τ - charm and beauty hadrons

2) At $p_T \geq 6$ GeV/c,

$$R_{AA}(\text{n.p.e.}) \sim R_{AA}(h^\pm)!$$

Contradicts naïve pQCD predictions

Surprising results -

- challenge our understanding of the energy loss mechanism
- force us to RE-think about the elastic-collisions energy loss, $\langle L \rangle$ etc
- **Requires direct measurements of c- and b-hadrons.**

Decay $e p_T$ vs. B- and C-hadron p_T

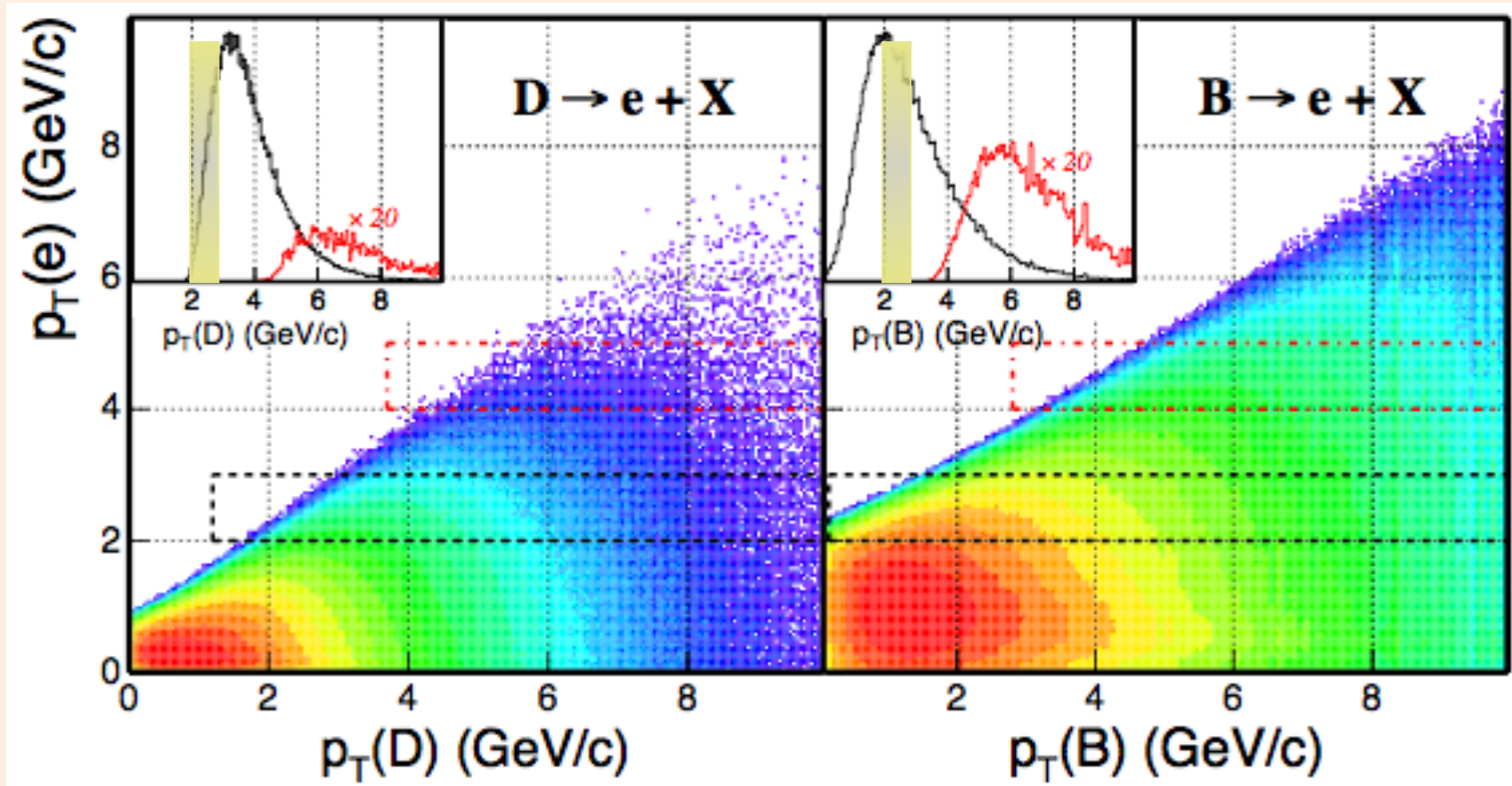

Key: ***Directly reconstructed heavy quark hadrons!***

Pythia calculation Xin Dong, USTC October 2005

Challenge: e.g. D^0 decay length

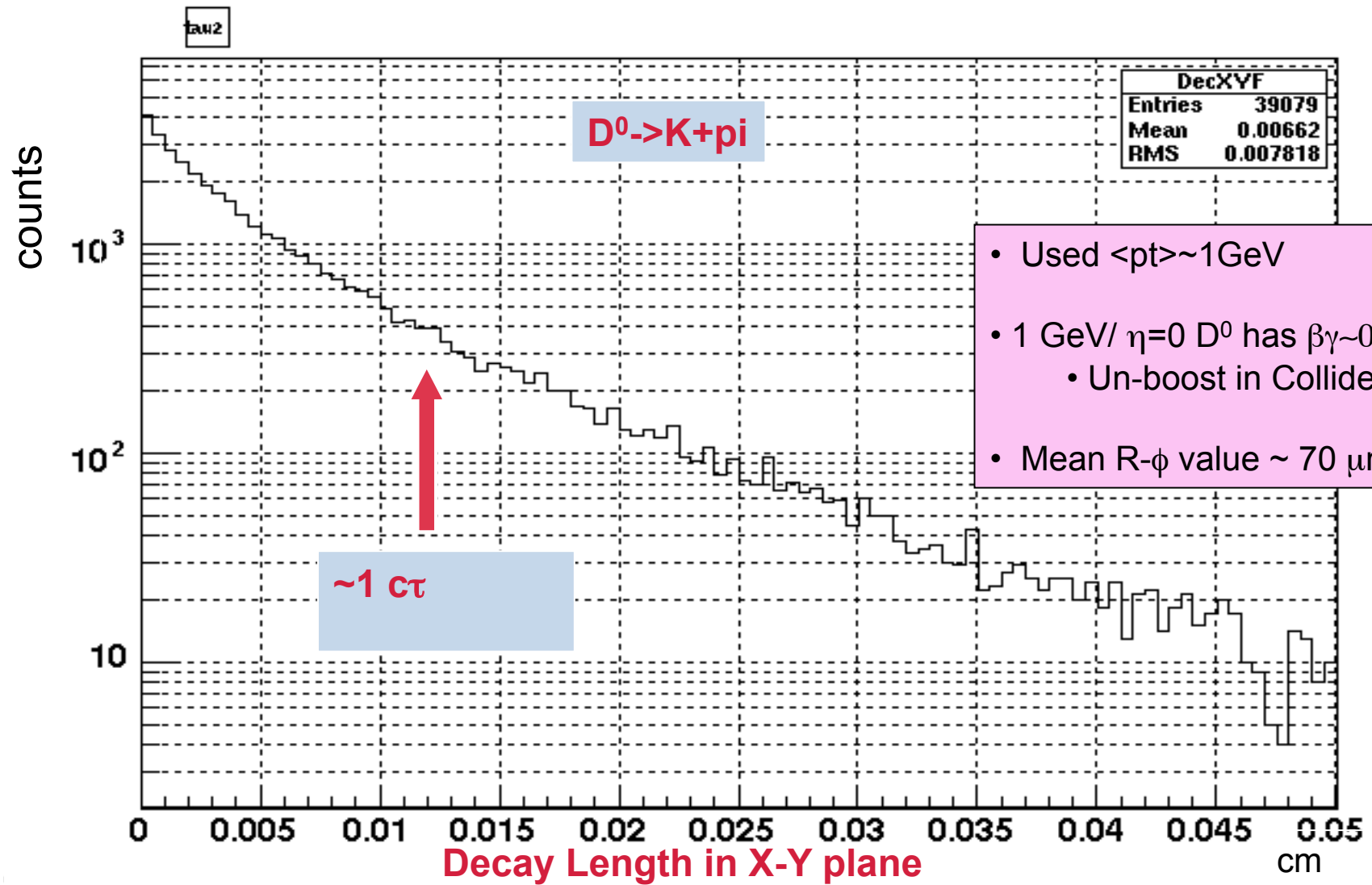

HFT Strategy

- Replace Drift Silicon with small/square Pixels
- Move as close to beam as possible
 - New beam pipe (Radius 4cm -> 2cm)
- Keep it as thin as possible
 - Si (300->50 microns)
 - Air-cool
 - $\sim 0.4\%$ X_0 thickness per layer
- Remove/install with ~ 20 micron overall envelope
 - Need special engineering

OLD (SVT)

NEW (HFT)

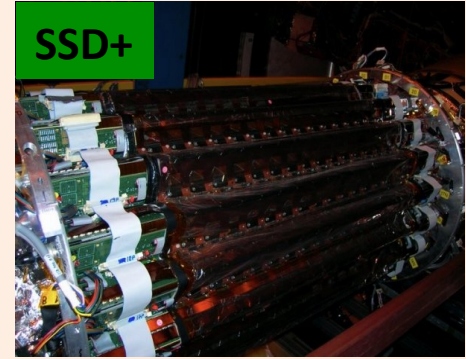
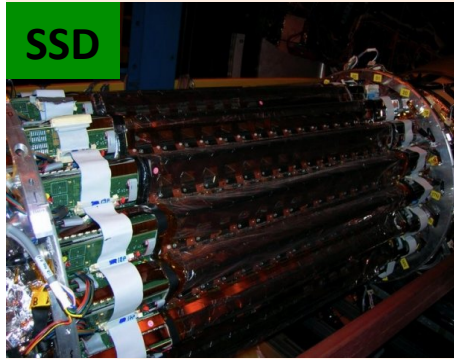

23cm

22cm

15cm

14cm

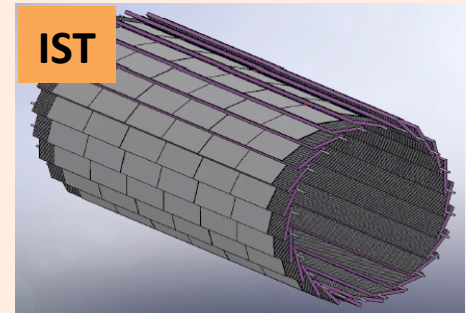

11cm

8cm

~6.5cm

2.5cm

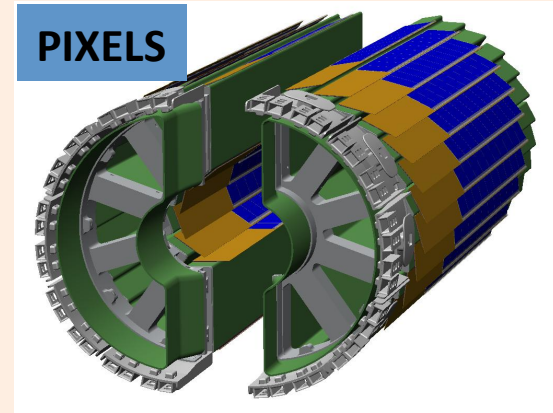

SVT: ~1.5% X0/layer

PXL: 0.3-0.5% X0/layer

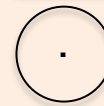
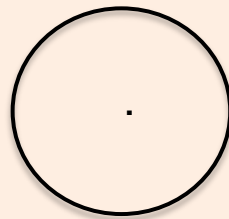

Detector resolutions differ by a factor of two but pointing by a factor of ten.

HFT Technology

- Low mass
- Near the event vertex
- Active pixels

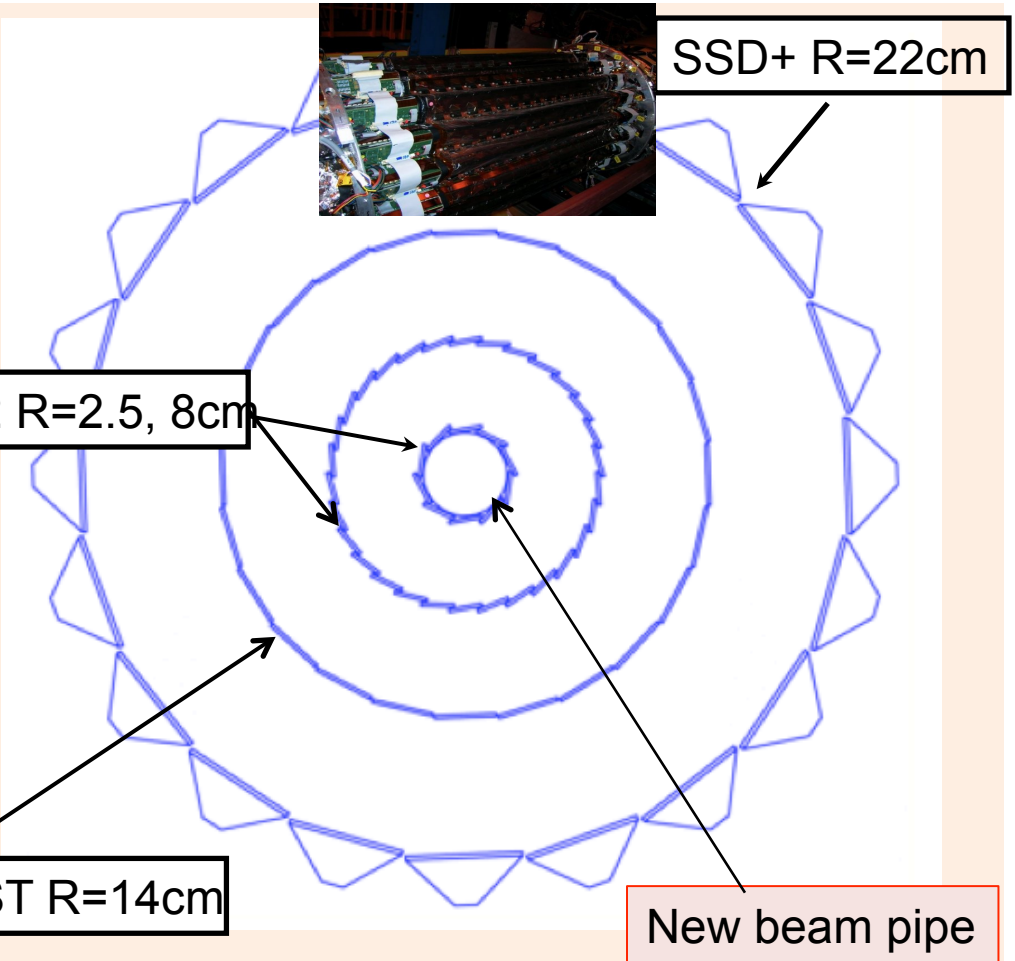
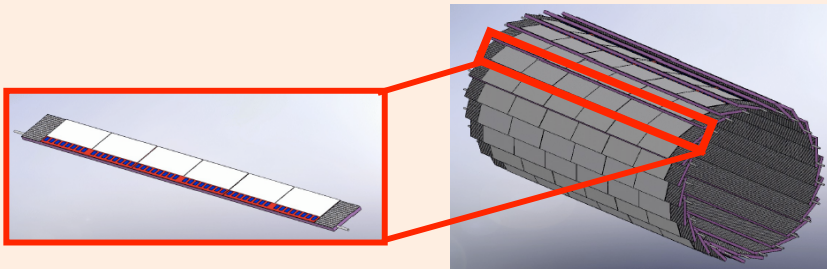
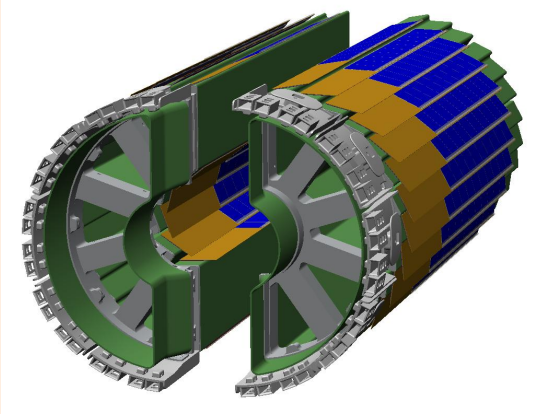

	Technology	Hit resolution R- ϕ (μm - μm)	Radiation Length
SSD+	double sided strips	30 - 857	1% X_0
IST	Silicon Strip Pad sensors	170 - 1700	1.2% X_0
PIXEL	Active Pixels	8.6 - 8.6	0.3% X_0

Projection error is a strong function of first-layer distance and thickness

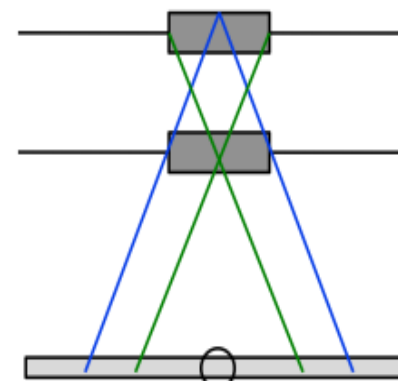
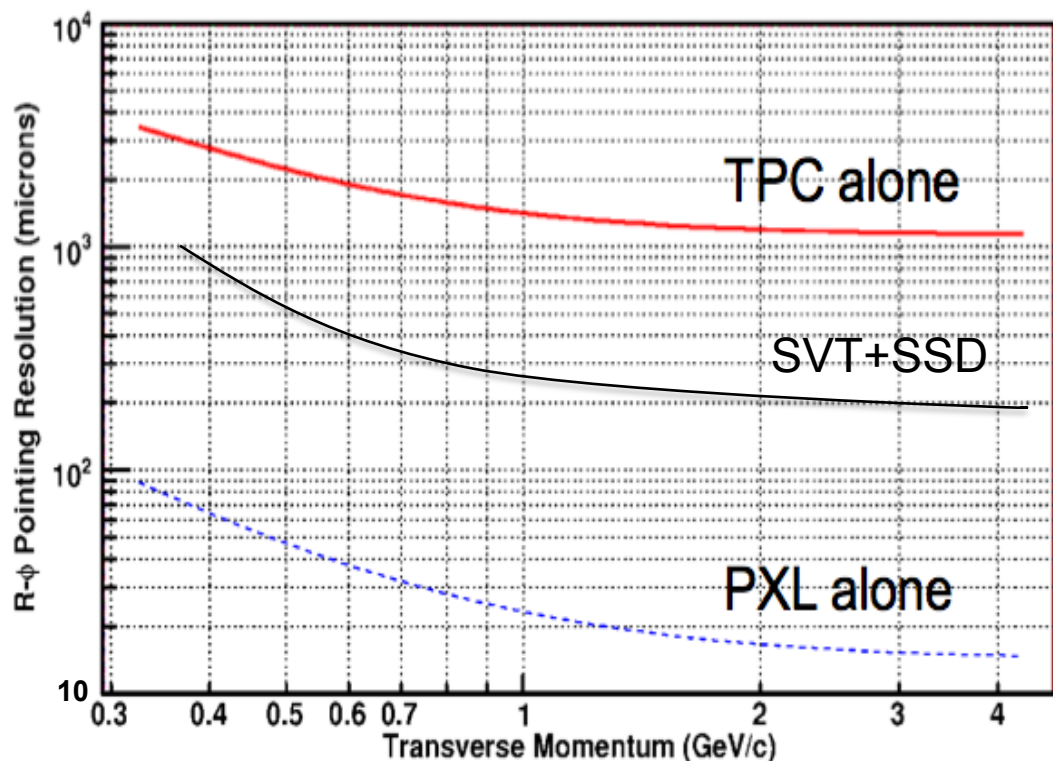

$$\sigma^2 = \frac{\sigma_1^2 r_2^2 + \sigma_2^2 r_1^2}{(r_2 - r_1)^2} + \frac{\theta_{mcs}^2 r_1^2}{\sin^2(\theta)}$$

$$\theta_{mcs} = \frac{13.6 (MeV/c)}{\beta p} \sqrt{\frac{x}{X_0}}$$

- In the critical region for Kaons from D^0 decay, 750 MeV to 1 GeV, the PXL single track pointing resolution is predicted to be 20-30 μm ... which is sufficient to pick out a D^0 with $c\tau = 125 \mu\text{m}$
- The system (and especially the PXL detector) is operating at the MCS limit

Glimpses at 200 GeV DATA

- (Relatively) low significance peaks have been observed already in the DATA but of limited physics reach

TPC only Cu+Cu

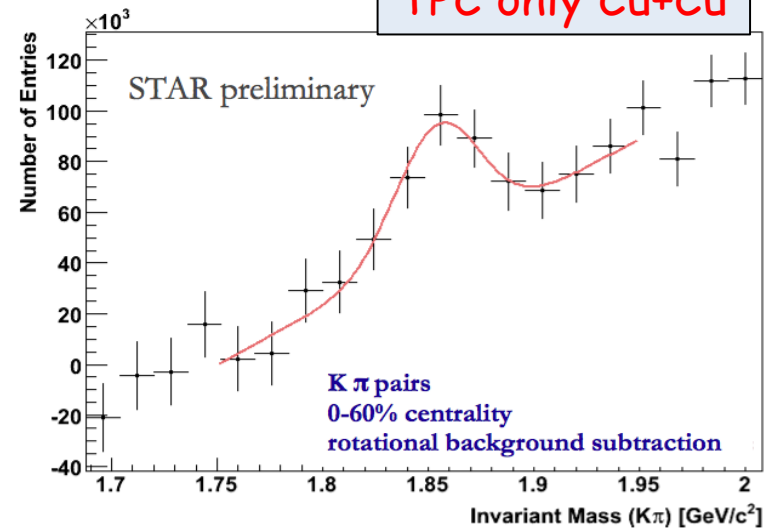

TPC+SVT+SSD Au+Au

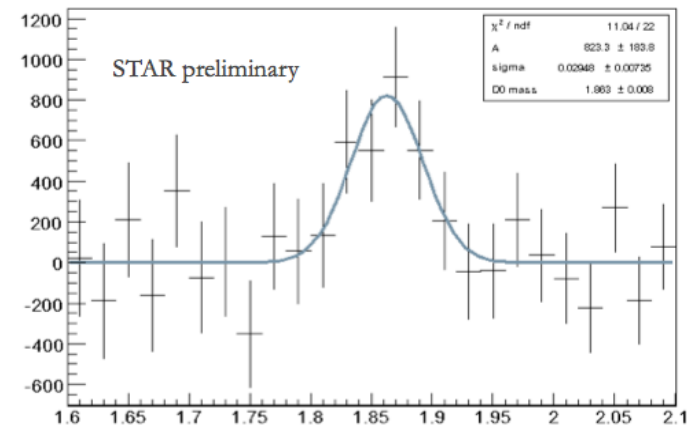
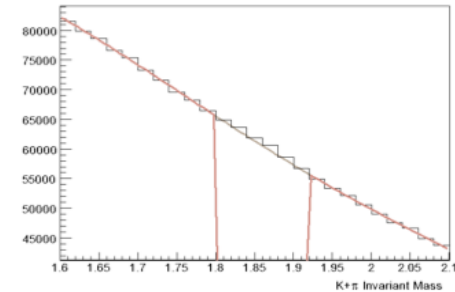
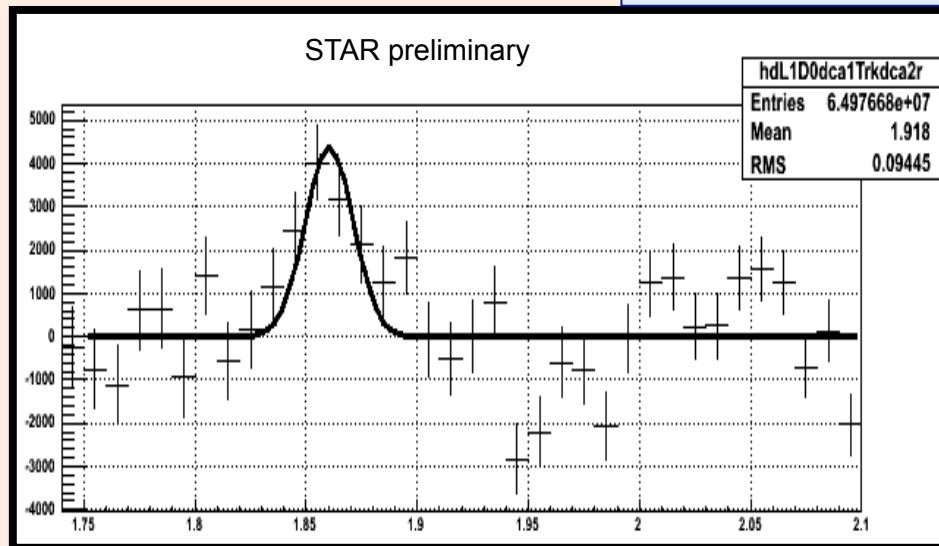

HFT Performance example on the $D^0 \rightarrow K\pi$ reconstruction

- Simulation of Au+Au@200GeV Hijing events with STAR tracking software including pixel pileup (RHIC-II luminosity) extrapolated to 500 M events (~one RHIC run).
- Identification done via topological cuts and PID using Time Of Flight

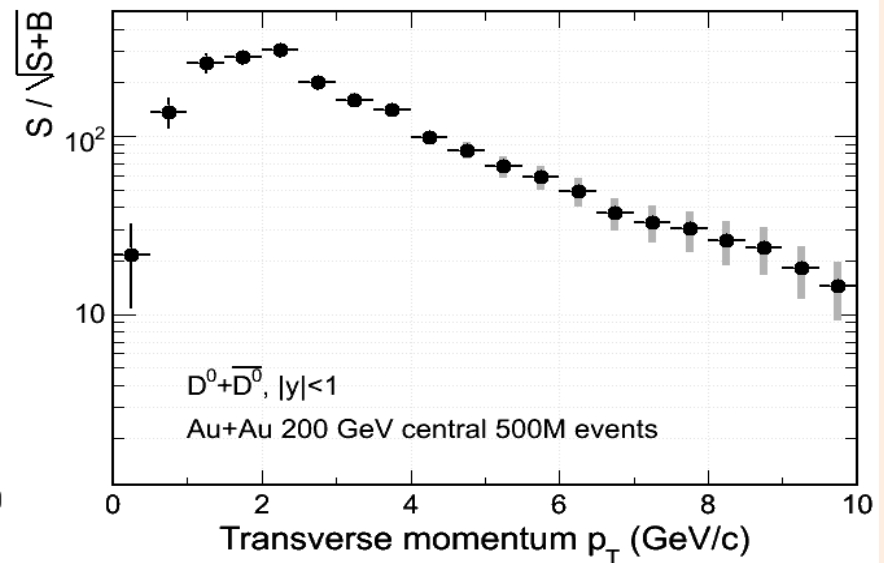
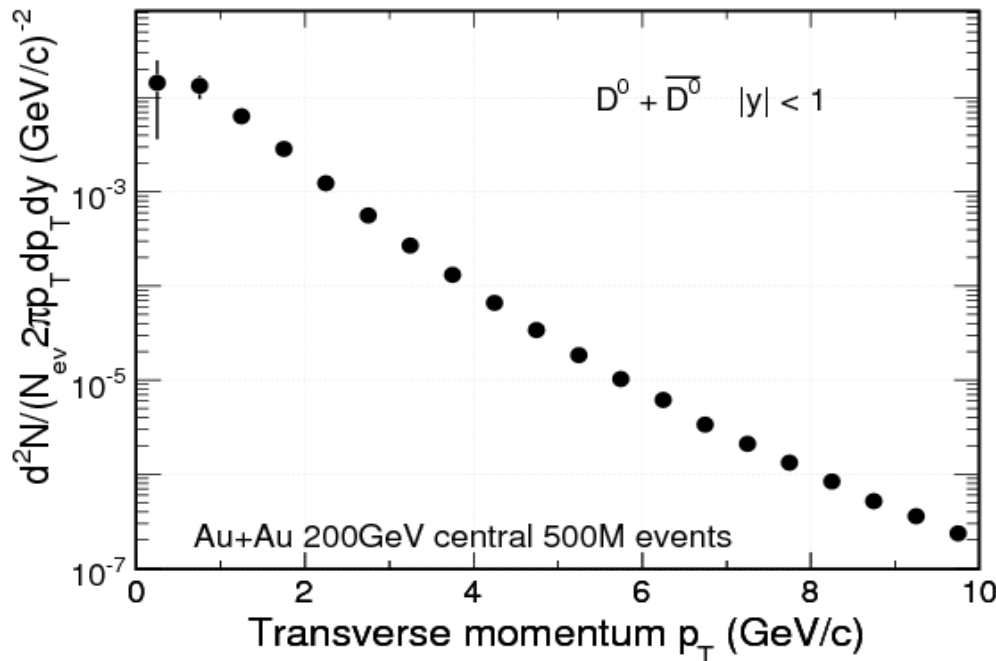
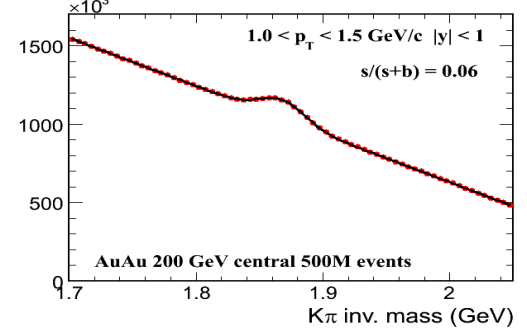
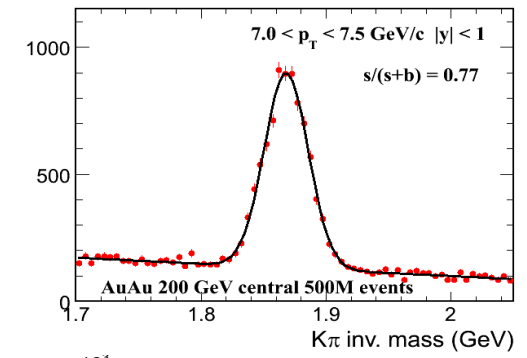
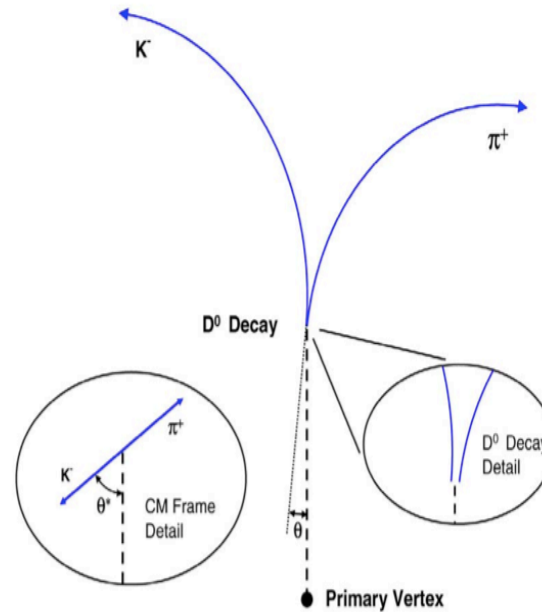

Heavy Quark Production

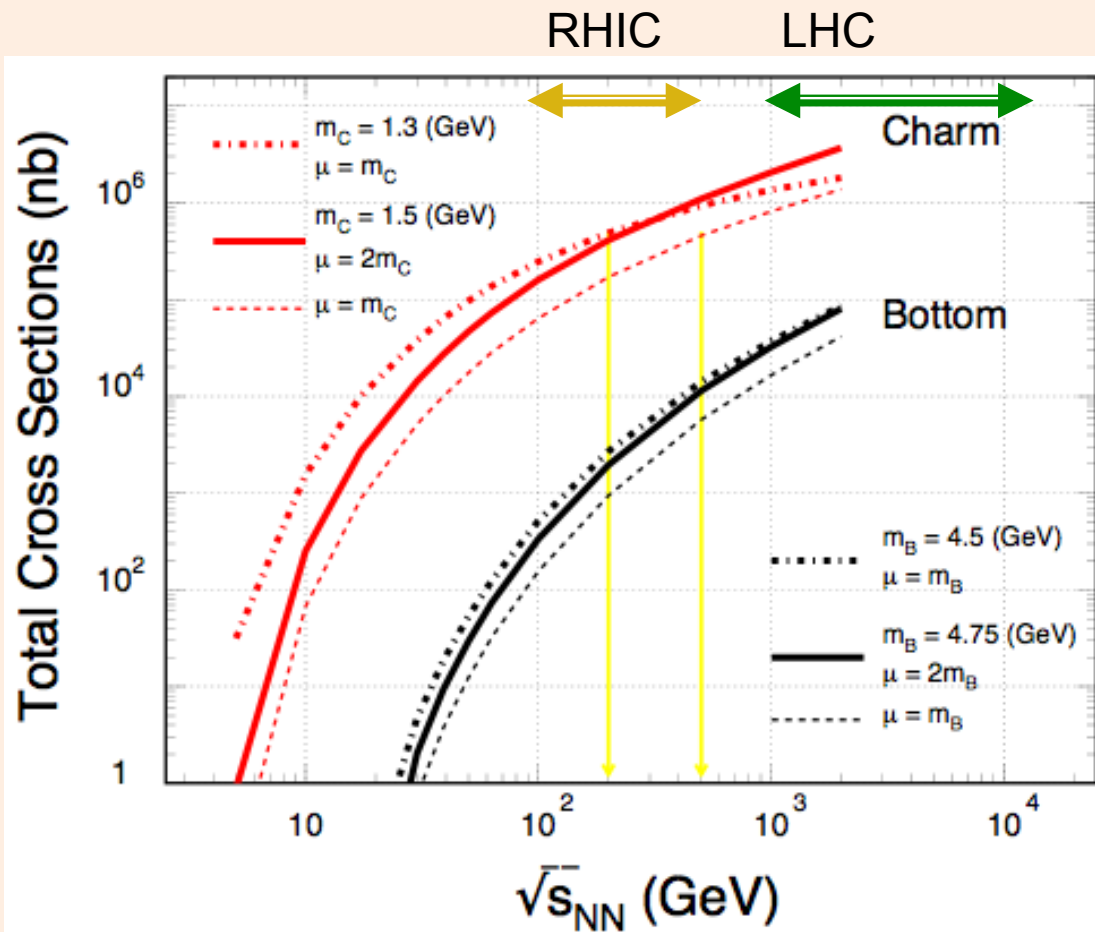

R. Vogt http://www-rnc.lbl.gov/ISMD/talks/Aug9/1400_Vogt.pdf

NLO pQCD predictions of charm and bottom for the total p+p hadro-production cross sections.

Renormalization scale and factorization scale were chosen to be equal.

RHIC: 200, 500 GeV

LHC: 900, 14000 GeV

Ideal energy range for studying pQCD predictions for heavy quark production.

Necessary reference for both, heavy ion and spin programs at RHIC.

Estimated error bars of measurement comparable to line thickness!

HFT - Charm Hadron v_2

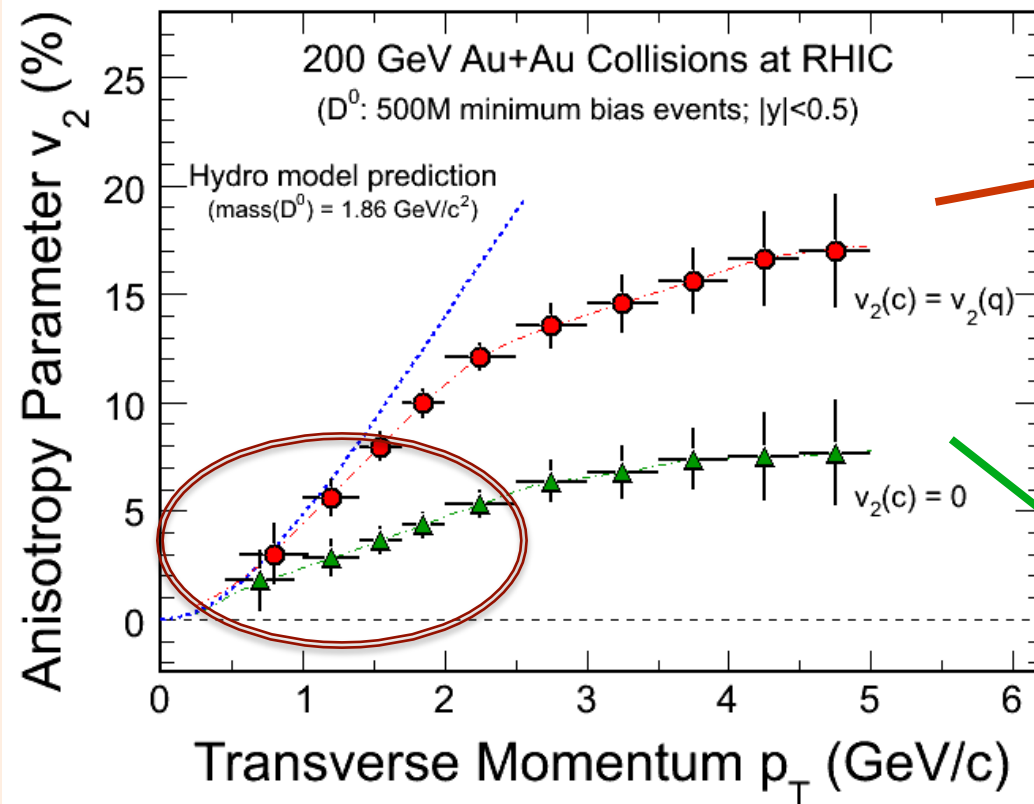

Charm-quark flow
▣ Thermalization
of light-quarks!

Charm-quark does
not flow
▣ Drag coefficients

- 200 GeV Au+Au minimum bias collisions (500M events).
- Charm collectivity \Rightarrow drag/diffusion constants \Rightarrow **medium properties!**

HFT - Charm Hadron v_2

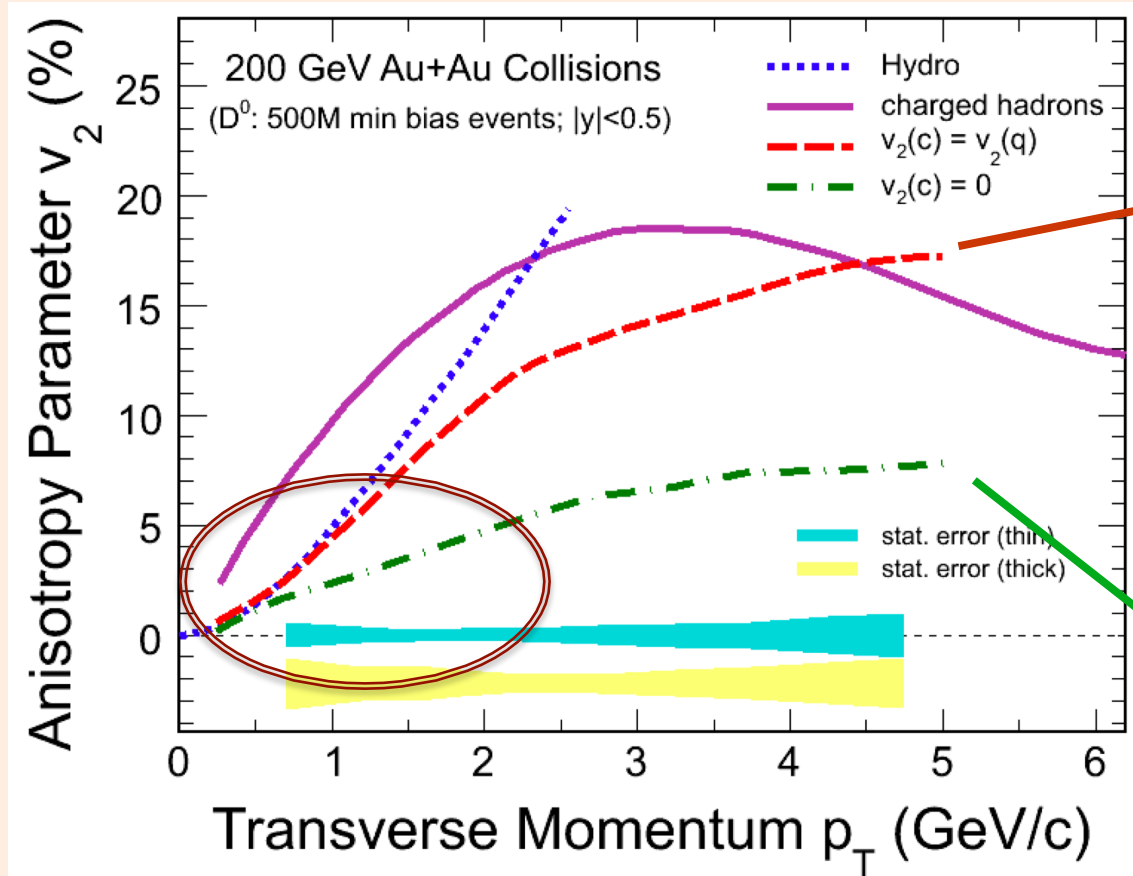

Charm-quark flow
 ■ Thermalization
 of light-quarks!

Charm-quark does
 not flow
 ■ Drag coefficients

- 200 GeV Au+Au minimum bias collisions (500M events).
- Charm collectivity \Rightarrow drag/diffusion constants \Rightarrow **medium properties!**

HFT - Charm Hadron R_{CP}

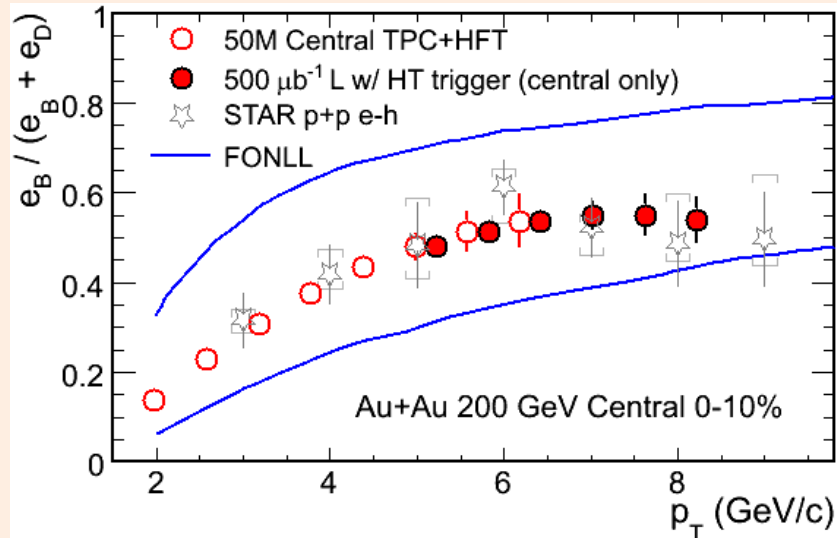

Simulation – D^0 s, NOT decay electrons

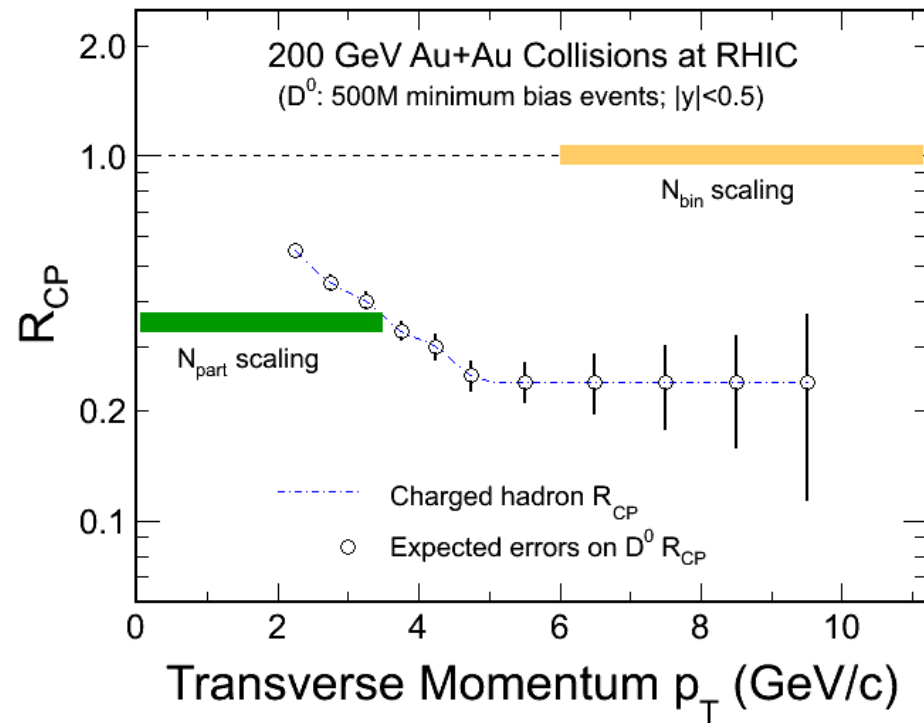

$$R_{CP} = \frac{dN / dp_T^{10\%}}{\langle N_{bin}^{10/(60-80)} \rangle dN / dp_T^{(60-80)\%}}$$

- Significant Bottom contributions in HQ decay electrons.
- 200 GeV Au+Au minimum bias collisions ($|y| < 0.5$ 500M events).
- Charm $R_{AA} \Rightarrow$ **energy loss mechanism!**

Λ_c Measurements

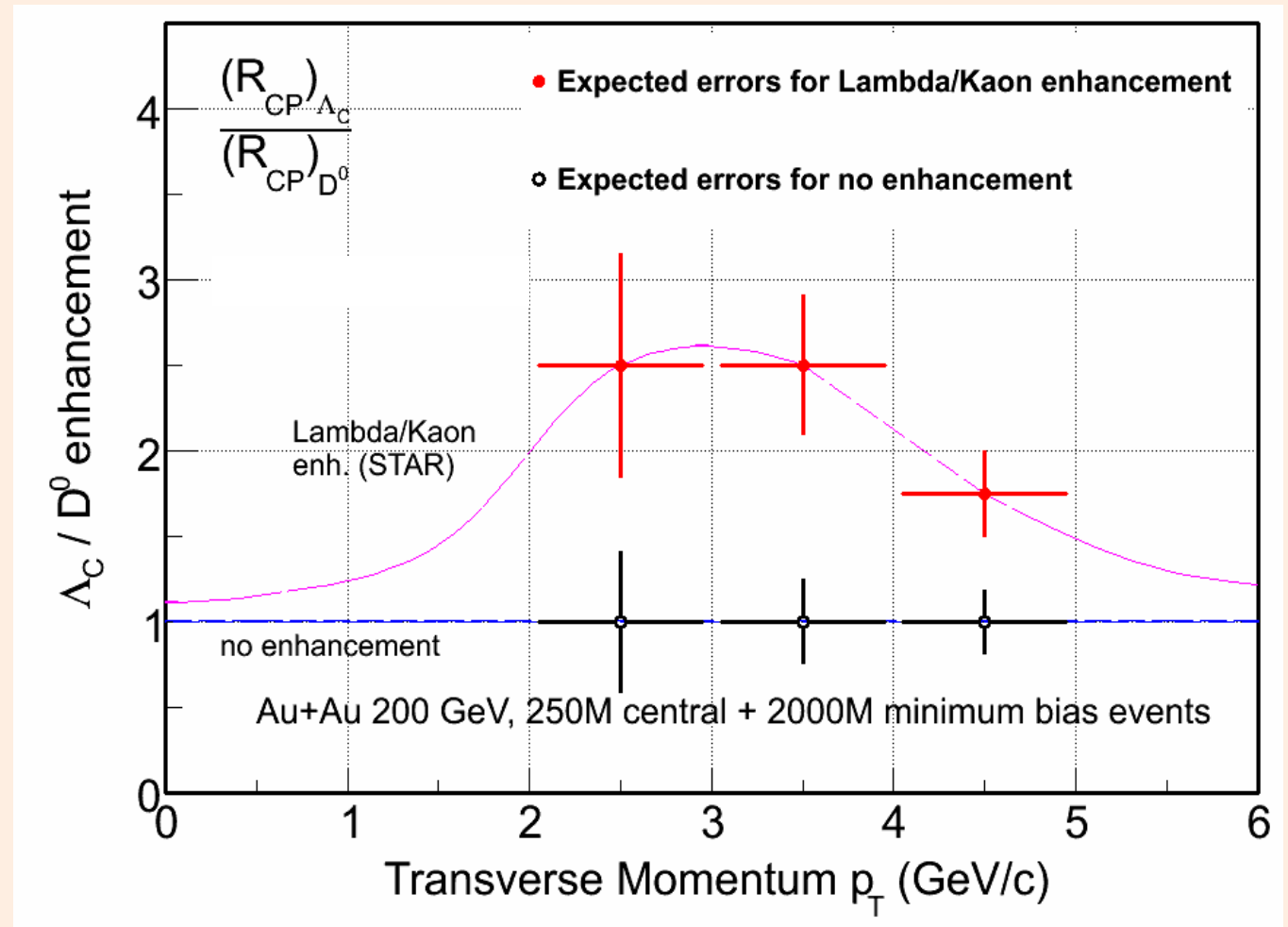

$\Lambda_c (\rightarrow p + K + \pi)$:

- 1) Lowest mass charm baryon
- 2) Total yield and Λ_c/D^0 ratios can be measured.

D_s Reconstruction

200 GeV Central Au+Au Collisions at RHIC

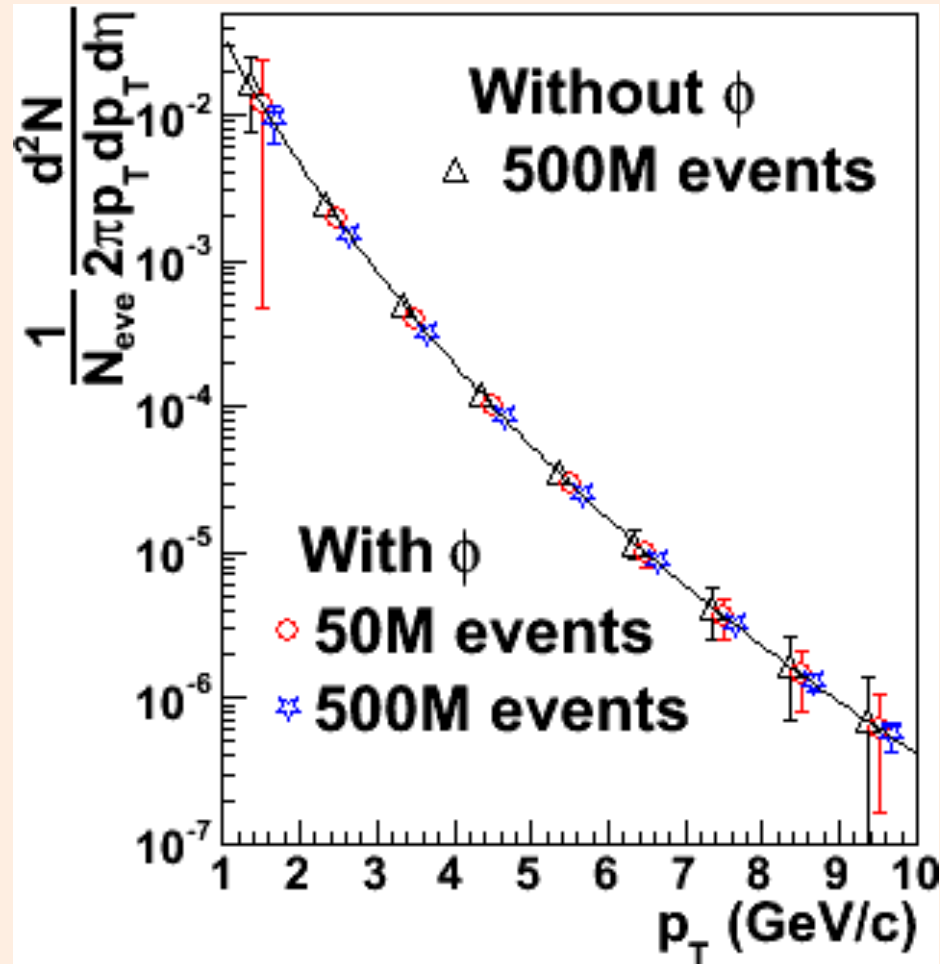

- $D_s \rightarrow K^+ K^- \pi$ (BR 5.5%)
- $D_s \rightarrow \phi \pi \rightarrow K^+ K^- \pi$ (BR 2.2%)
- mass = 1968.49 ± 0.34 MeV
- **decay length** $\sim 150 \mu\text{m}$

- **Work in progress ...**
- 200 GeV central Au+Au
- Ideal PID
- Power-law spectrum with:
 $n = 11, \langle p_T \rangle = 1$ GeV/c

0.5B events will work!

Strategies for Bottom Measurement

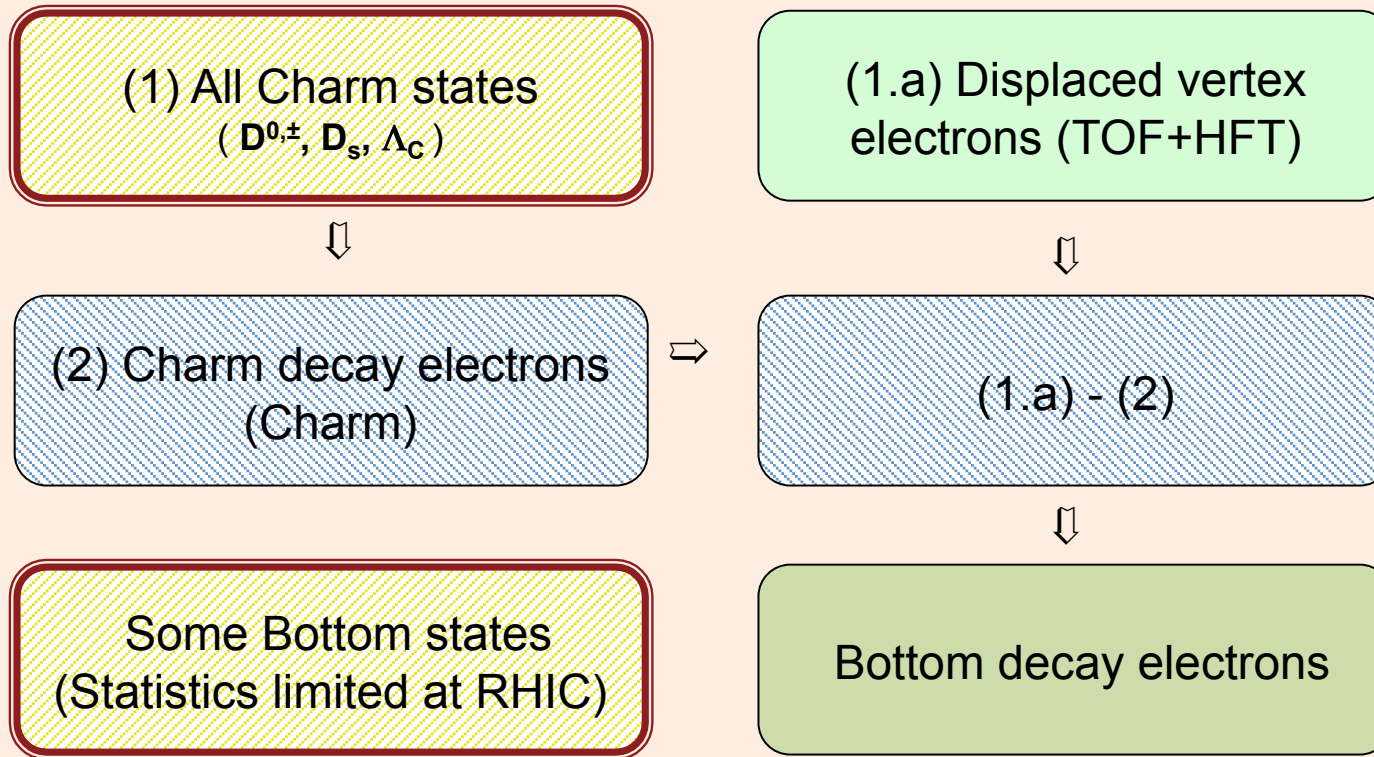

Measure **Charm** and **Bottom** hadron:
Cross sections, Spectra and v_2

B-meson capabilities (in progress)

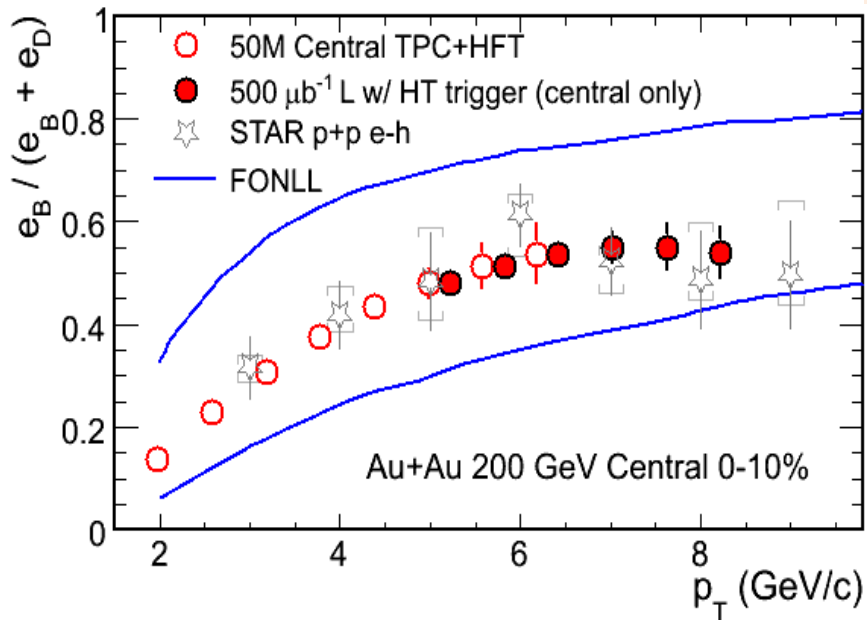
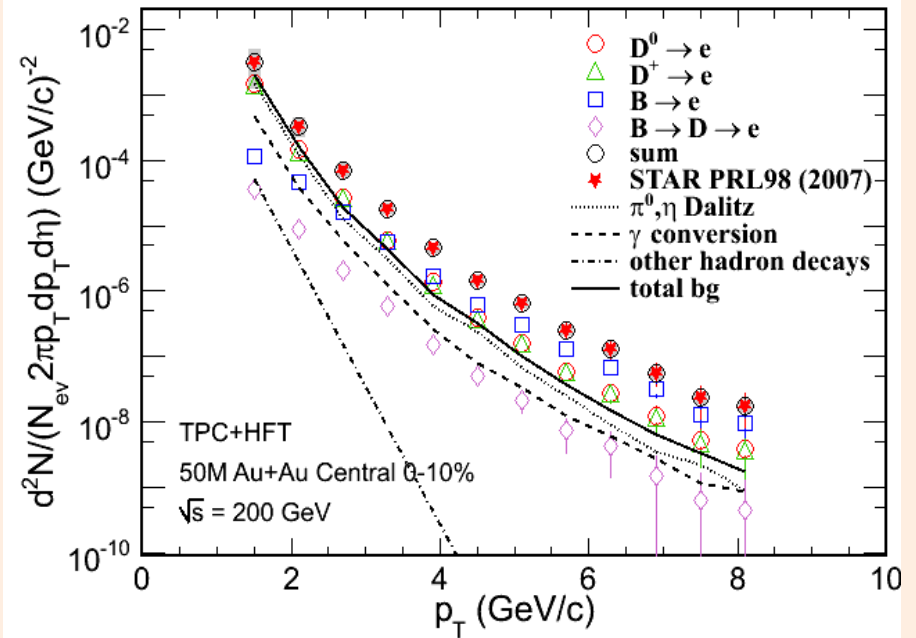
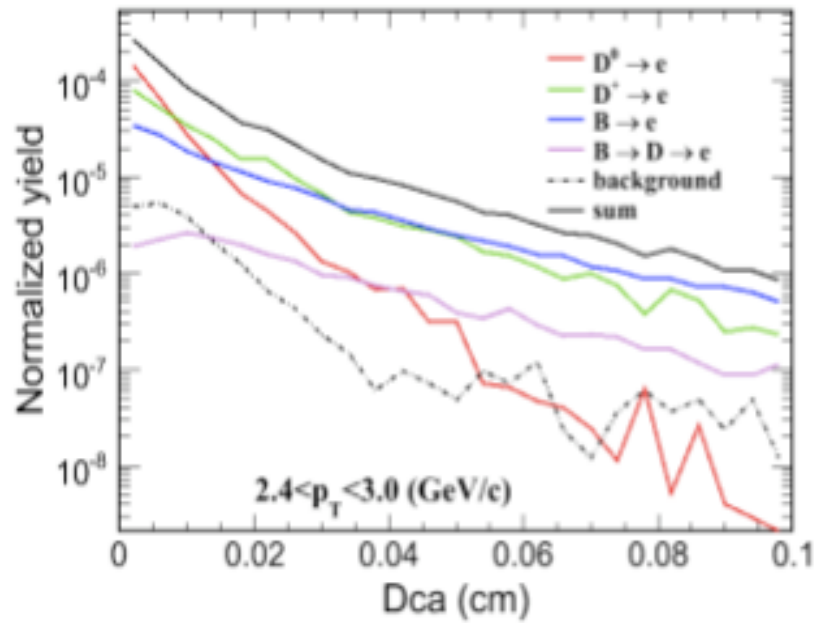

B \rightarrow e+X approach
Rate limited, not resolution

c- and b-decay Electrons

H. van Hees et al. Eur. Phys. J. **C61**, 799(2009). (arXiv: 0808.3710)

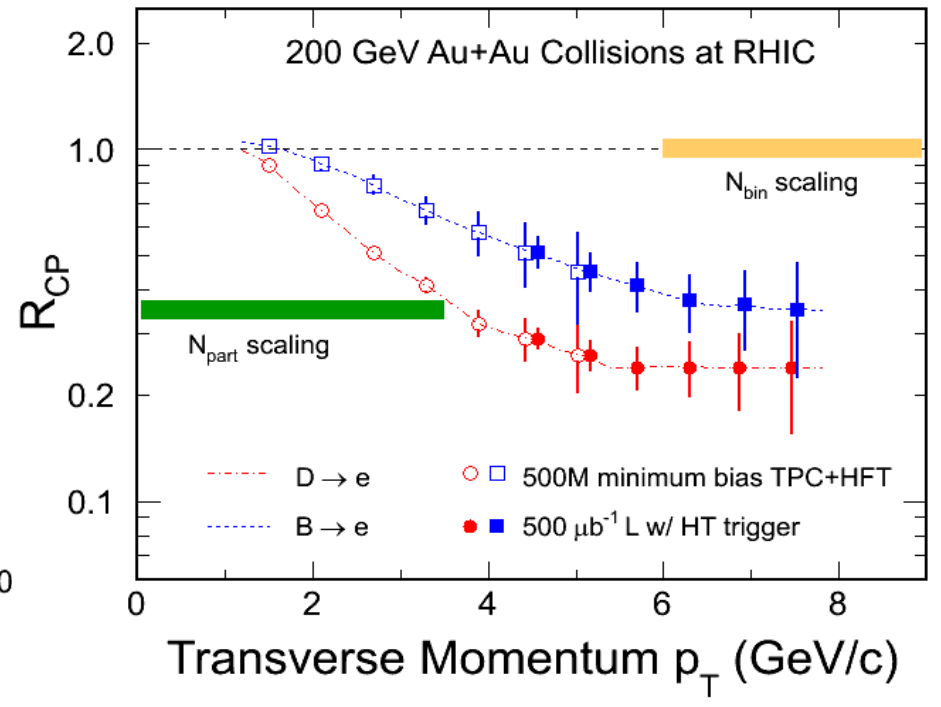
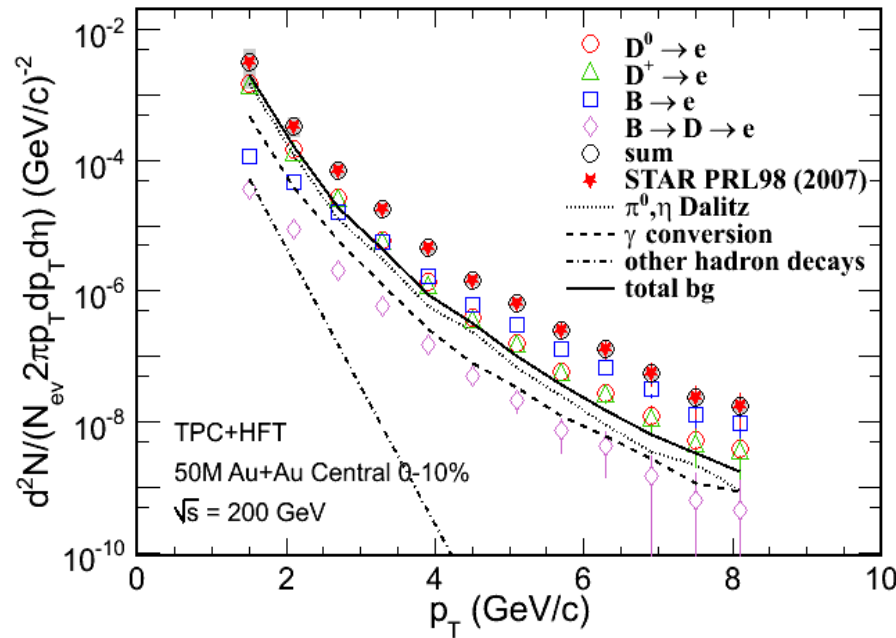

$$R_{CP} = \frac{dN / dp_T^{10\%}}{\langle N_{bin}^{10/(60-80)} \rangle dN / dp_T^{(60-80)\%}}$$

- DCA cuts \Rightarrow **c- and b-decay electron distributions and R_{CP}**
- 200 GeV Au+Au minimum biased collisions ($|y| < 0.5$ 500M events)

Summary

- Detailed spectra of heavy flavor (c, b) is an invaluable piece of information
- First generation of detectors needs smart replacements
- The **Heavy Flavor Tracker** in STAR is the most advanced answer to this need

Spares

Partonic Collectivity at RHIC

$\sqrt{s_{NN}} = 200 \text{ GeV } ^{197}\text{Au} + ^{197}\text{Au}$ Collisions at RHIC

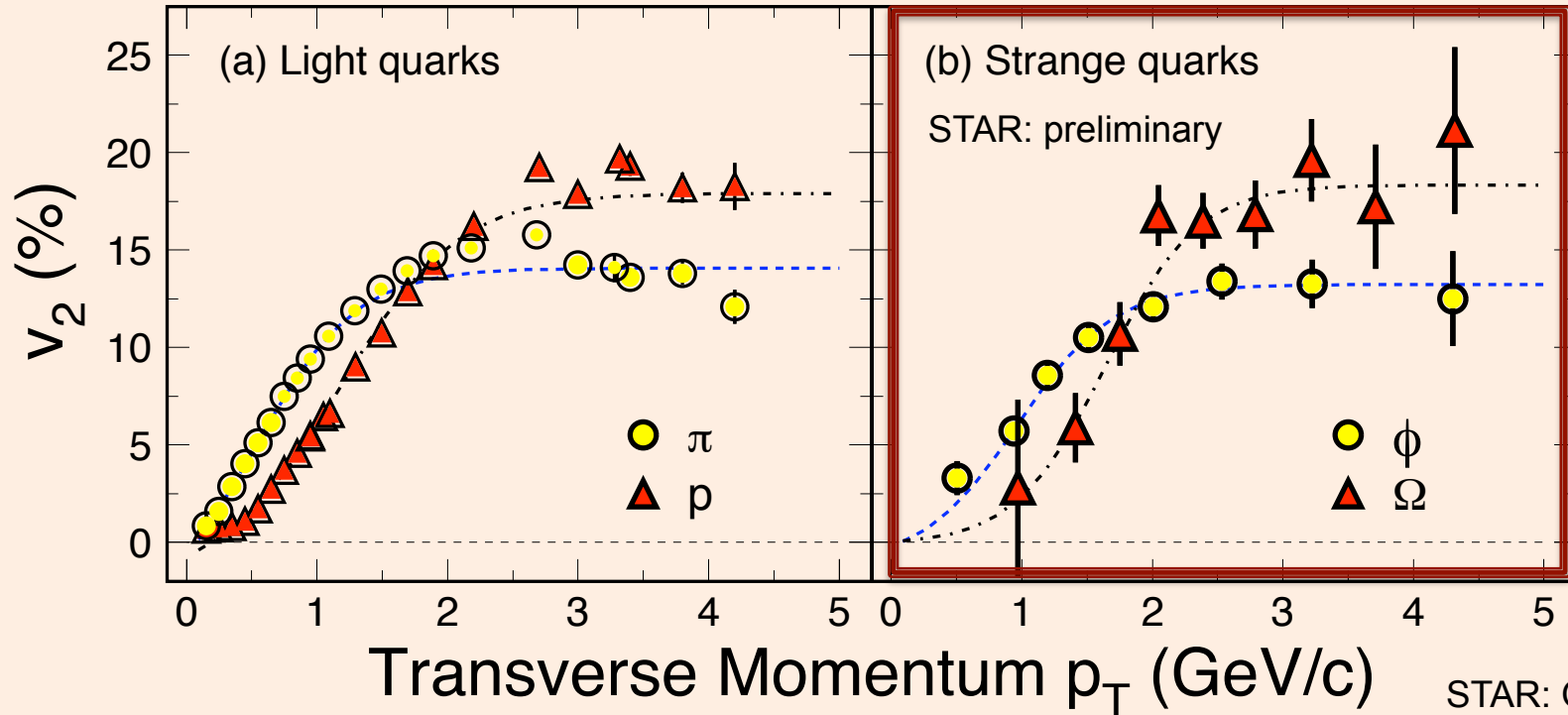

Low p_T ($\leq 2 \text{ GeV}/c$): hydrodynamic mass ordering

High p_T ($> 2 \text{ GeV}/c$): number of quarks ordering

s-quark hadron: smaller interaction strength in hadronic medium

light- and s-quark hadrons: similar v_2 pattern

=> Collectivity developed at partonic stage!

The di-Lepton Program at STAR

TOF + TPC + *HFT*

- (1) σ
- (2) V_2
- (3) R_{AA}

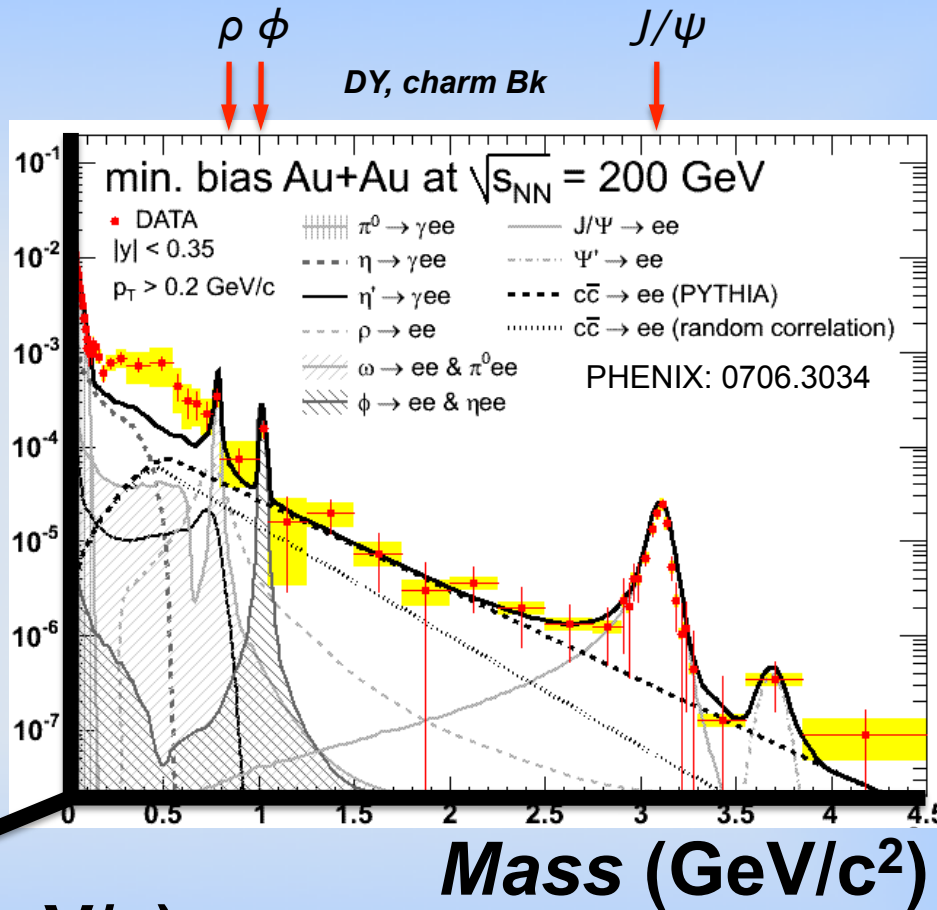

p_T (GeV/c)

✓ Direct radiation from the Hot/Dense Medium

✓ Chiral symmetry Restoration

⇒ A robust di-lepton physics program extending STAR scientific reach

Quark Masses

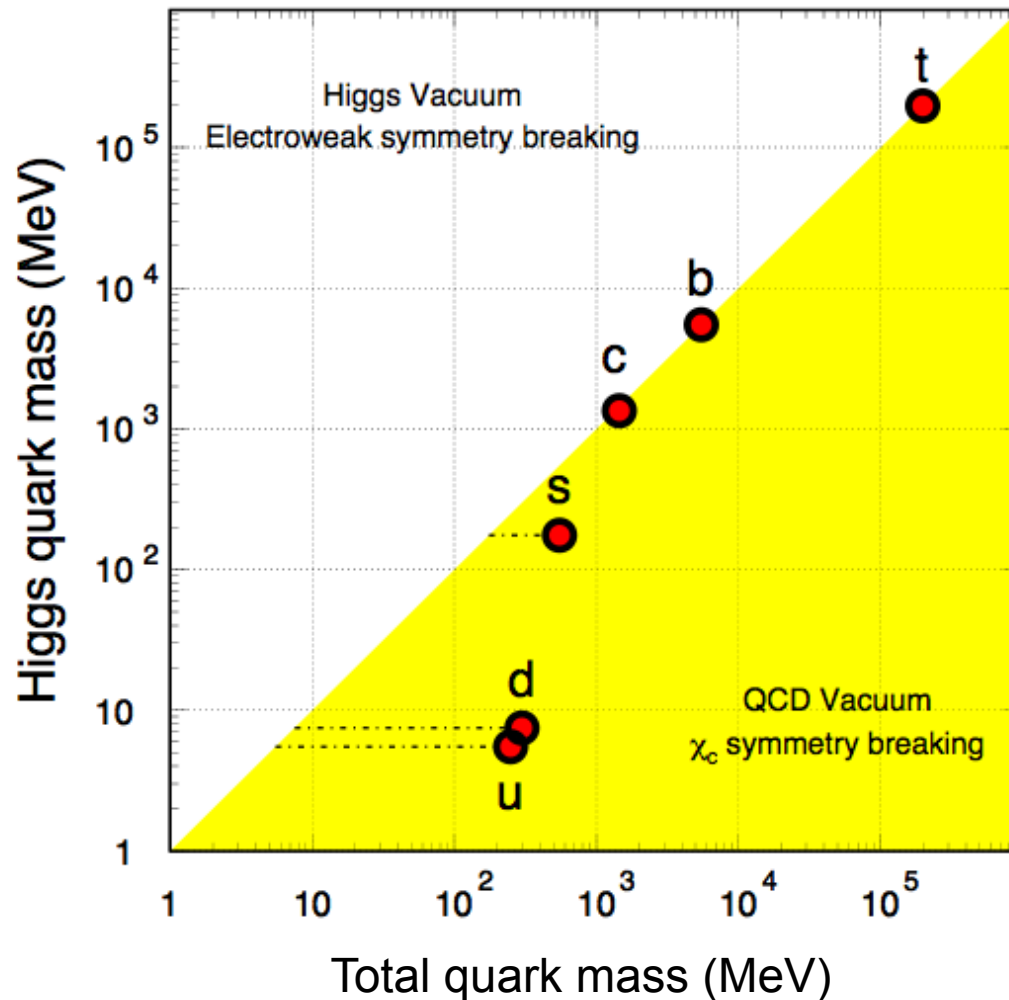

- Higgs mass: electro-weak symmetry breaking (current quark mass).
- QCD mass: Chiral symmetry breaking (constituent quark mass).
- ⇒ Strong interactions do not affect heavy-quark mass.
- ⇒ New scale compare to the excitation of the system.
- ⇒ Study properties of the hot and dense medium at the **foremost early stage** of heavy-ion collisions.
- ⇒ Explore pQCD at RHIC.

X. Zhu, *et al*, Phys. Lett. **B647**, 366(2007).

Requirement for the HFT

	Measurements	Requirements
Heavy Ion	heavy-quark hadron v_2 - the heavy-quark collectivity	<ul style="list-style-type: none"> - Low material budget for high reconstruction efficiency - p_T coverage ≥ 0.5 GeV/c - mid-rapidity - High counting rate
	heavy-quark hadron R_{AA} - the heavy-quark energy loss	<ul style="list-style-type: none"> - High p_T coverage ~ 10 GeV/c
p+p	energy and spin dependence of the heavy-quark production	<ul style="list-style-type: none"> - p_T coverage ≥ 0.5 GeV/c
	gluon distribution with heavy quarks	<ul style="list-style-type: none"> - wide rapidity and p_T coverage

ϕ -meson Flow: Partonic Flow

STAR: Phys. Rev. Lett. **99**, 112301(2007).

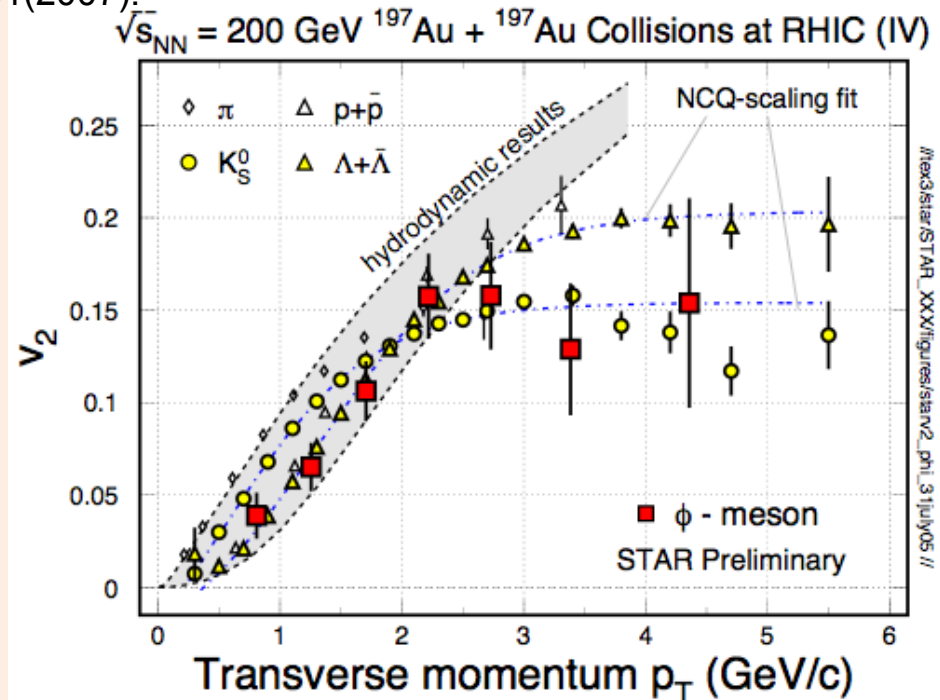
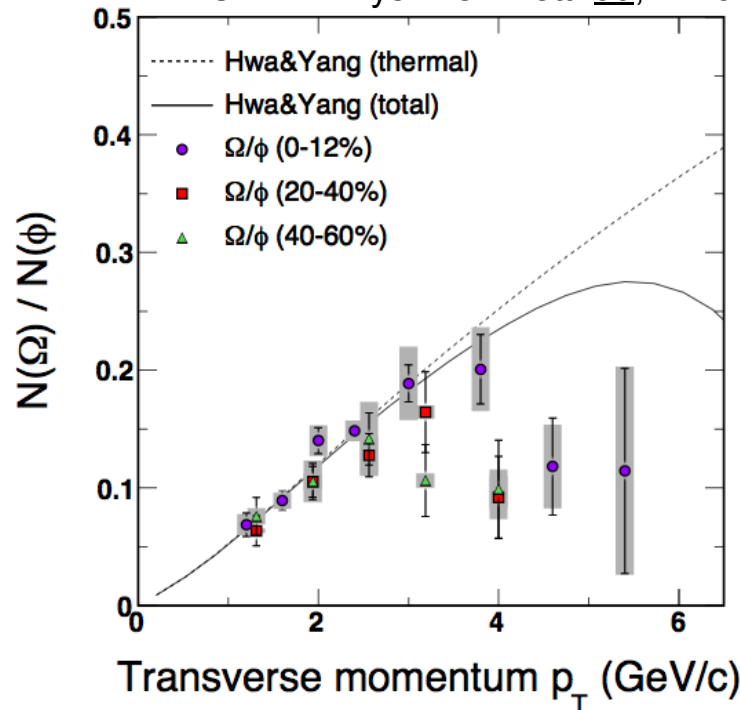

“ ϕ -mesons (and other hadrons) are produced via coalescence of seemingly thermalized quarks in central Au+Au collisions. This observation implies *hot and dense matter with partonic collectivity* has been formed at RHIC”

In order to test early thermalization: $v_2(p_T)$ of c- and b-hadrons data are needed!

Charm Cross Sections at RHIC

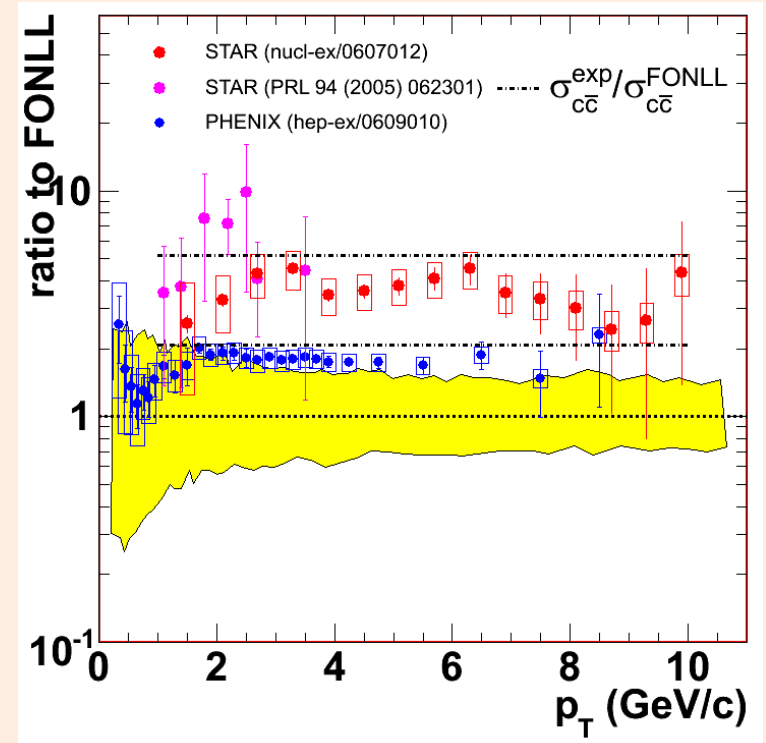
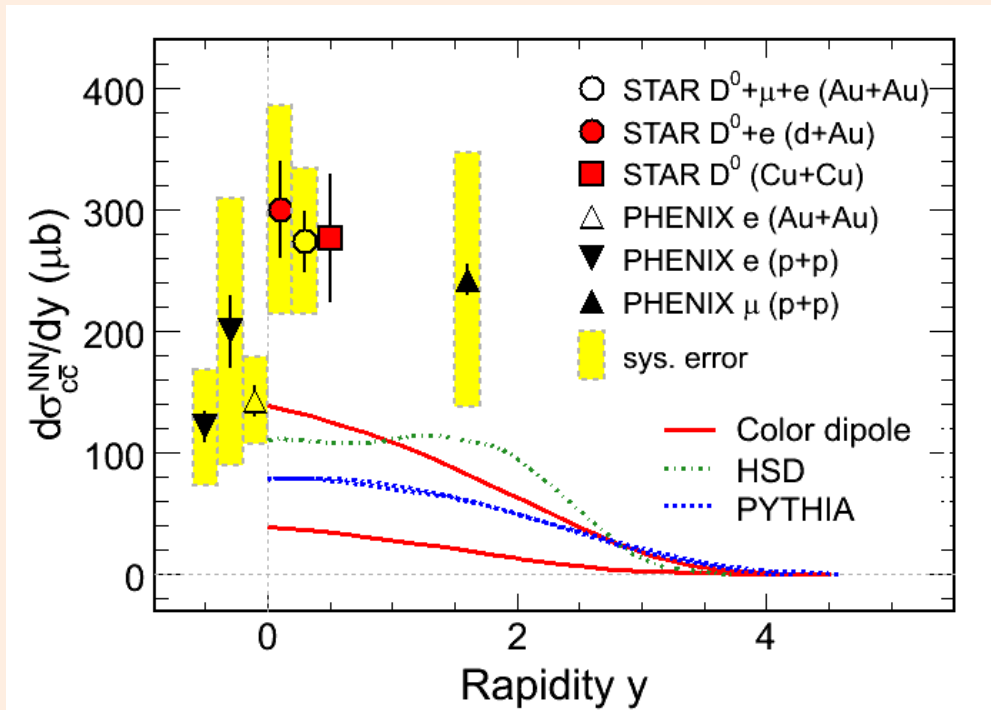

- 1) Large systematic uncertainties in the measurements
- 2) New displaced, topologically reconstructed measurements for c- and b-hadrons are needed \Rightarrow **Upgrade**

SVT+SSD D0-vertex resolution (simulation)

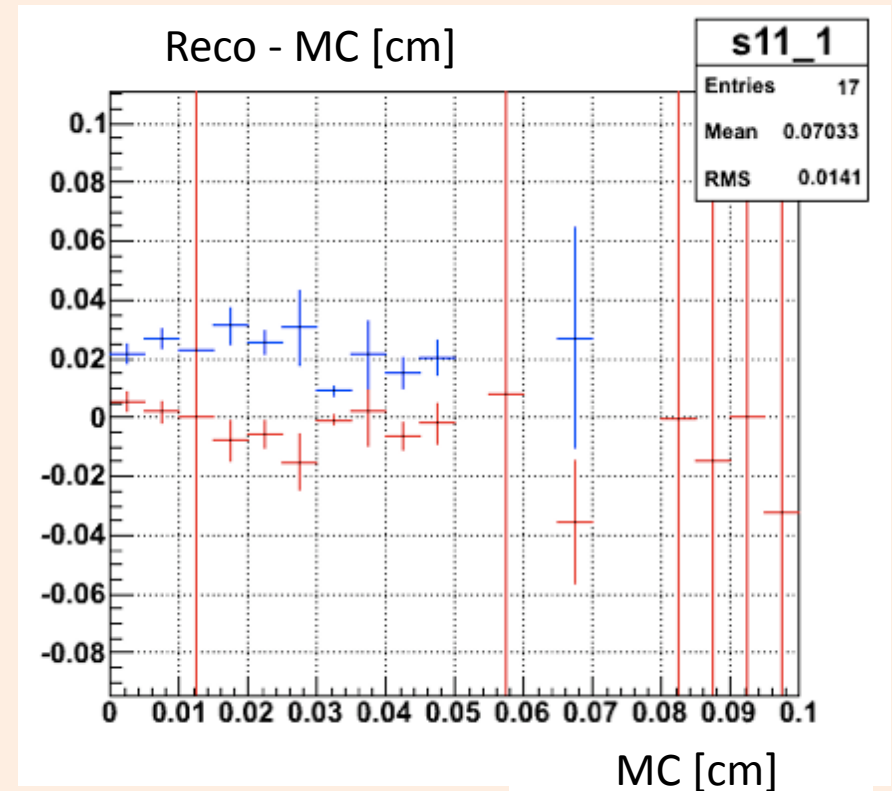
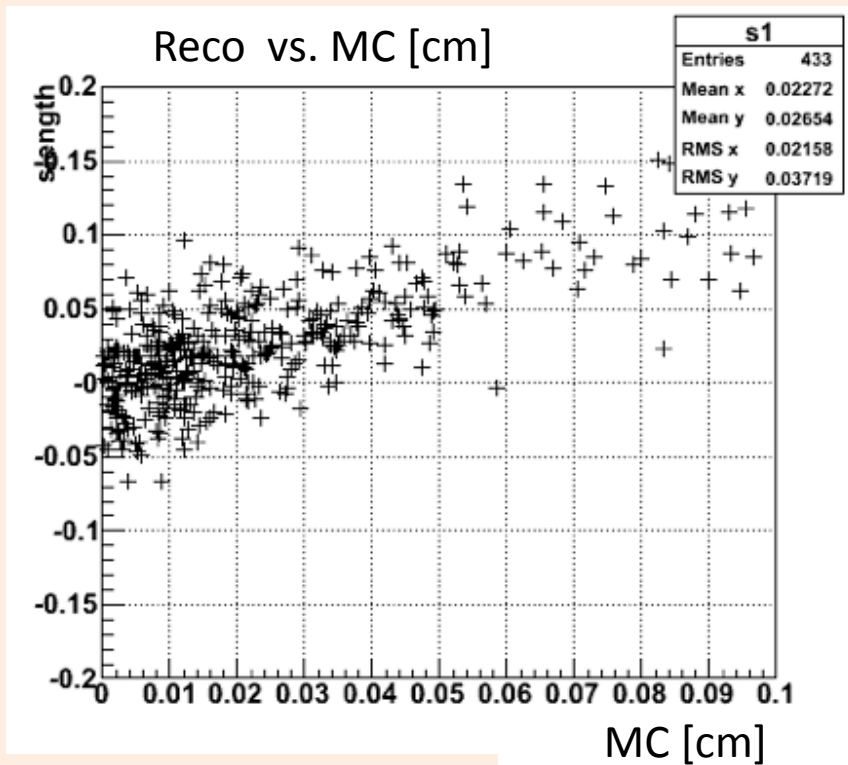

- Left : correlation between reconstructed path length and MC
- Right : Decay length resolution
 - There is no systematic shift (red crosses = mean) in reconstructed quantities.
 - The standard deviation (blue crosses) of the distribution (*reco-MC*) is flat at $\sim 250 \mu\text{m}$, which is of the order of the resolution of (SSD+SVT).

Charm Baryon/Meson Ratios

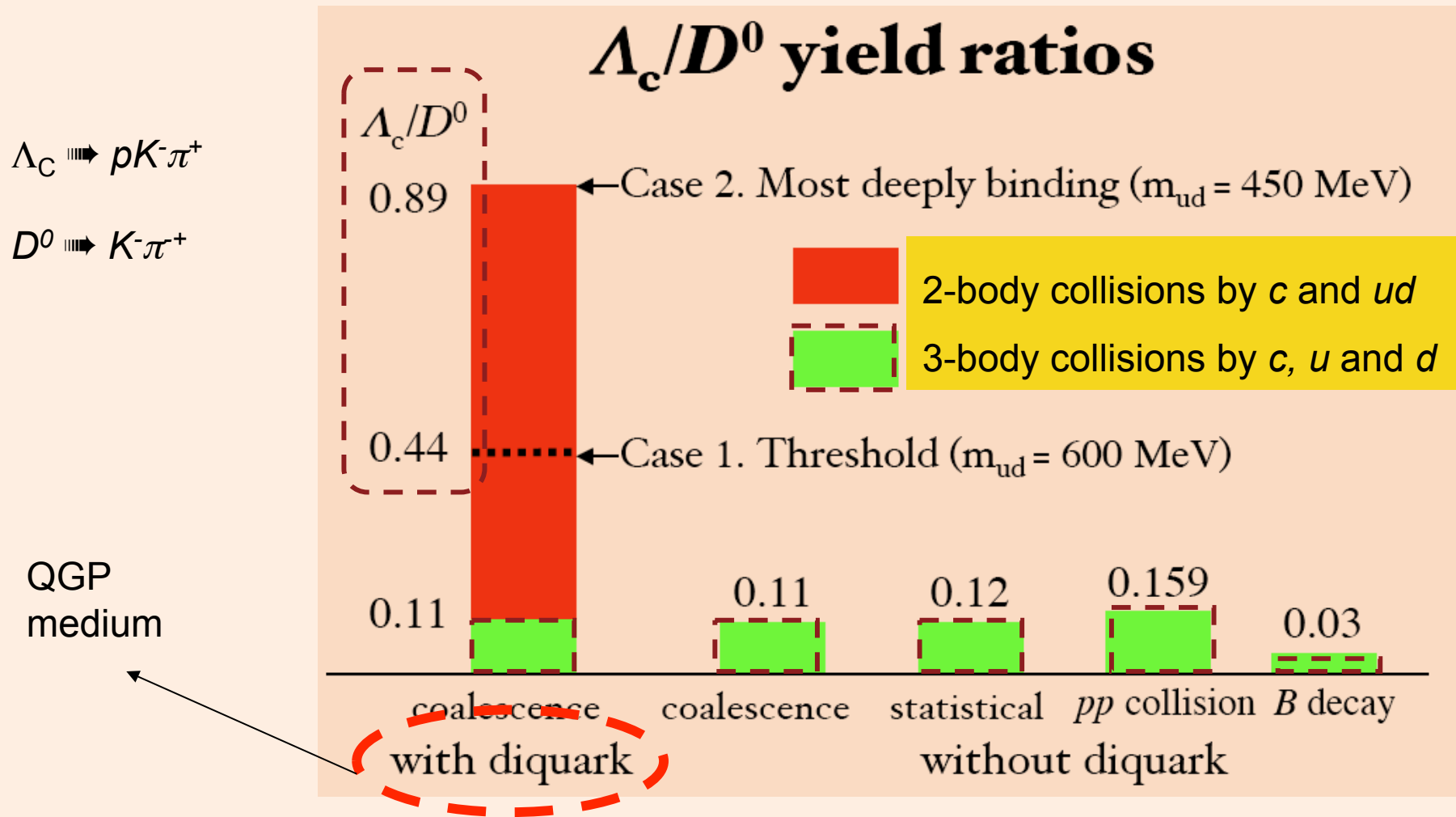

Y. Oh, C.M. Ko, S.H. Lee, S. Yasui, Phys. Rev. **C79**, 044905(2009).

S.H. Lee, K.Ohnishi, S. Yasui, I-K.Yoo, C.M. Ko, Phys. Rev. Lett. **100**, 222301(2008).

Λ_c Measurements

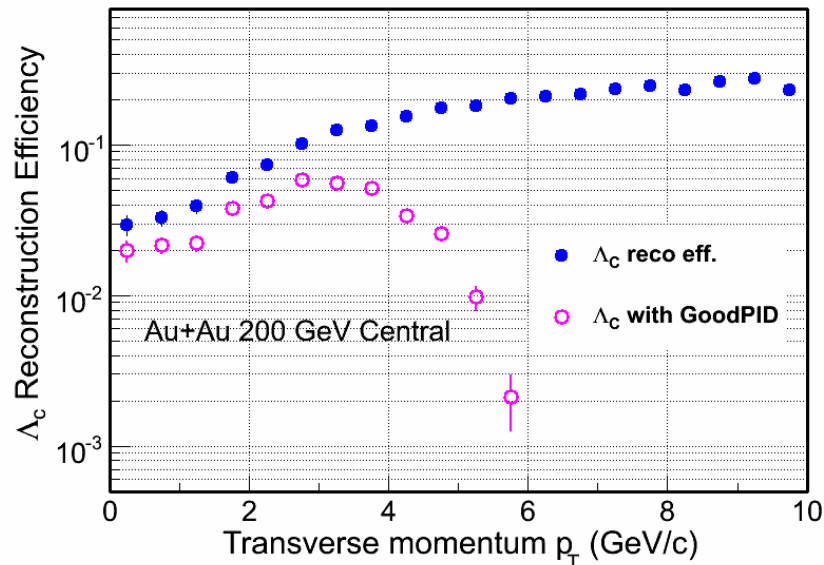
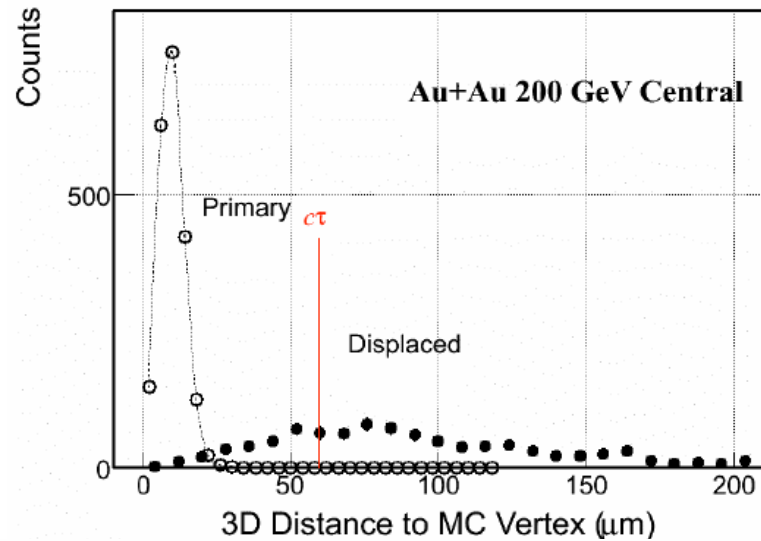

$\Lambda_c (\rightarrow p + K + \pi)$:

- 1) Lowest mass charm baryon
- 2) Total yield and Λ_c/D^0 ratios can be measured.

