

Measurement of longitudinal single-spin asymmetries for W^\pm boson production in polarized p+p collision at $\sqrt{s}=510$ GeV at RHIC

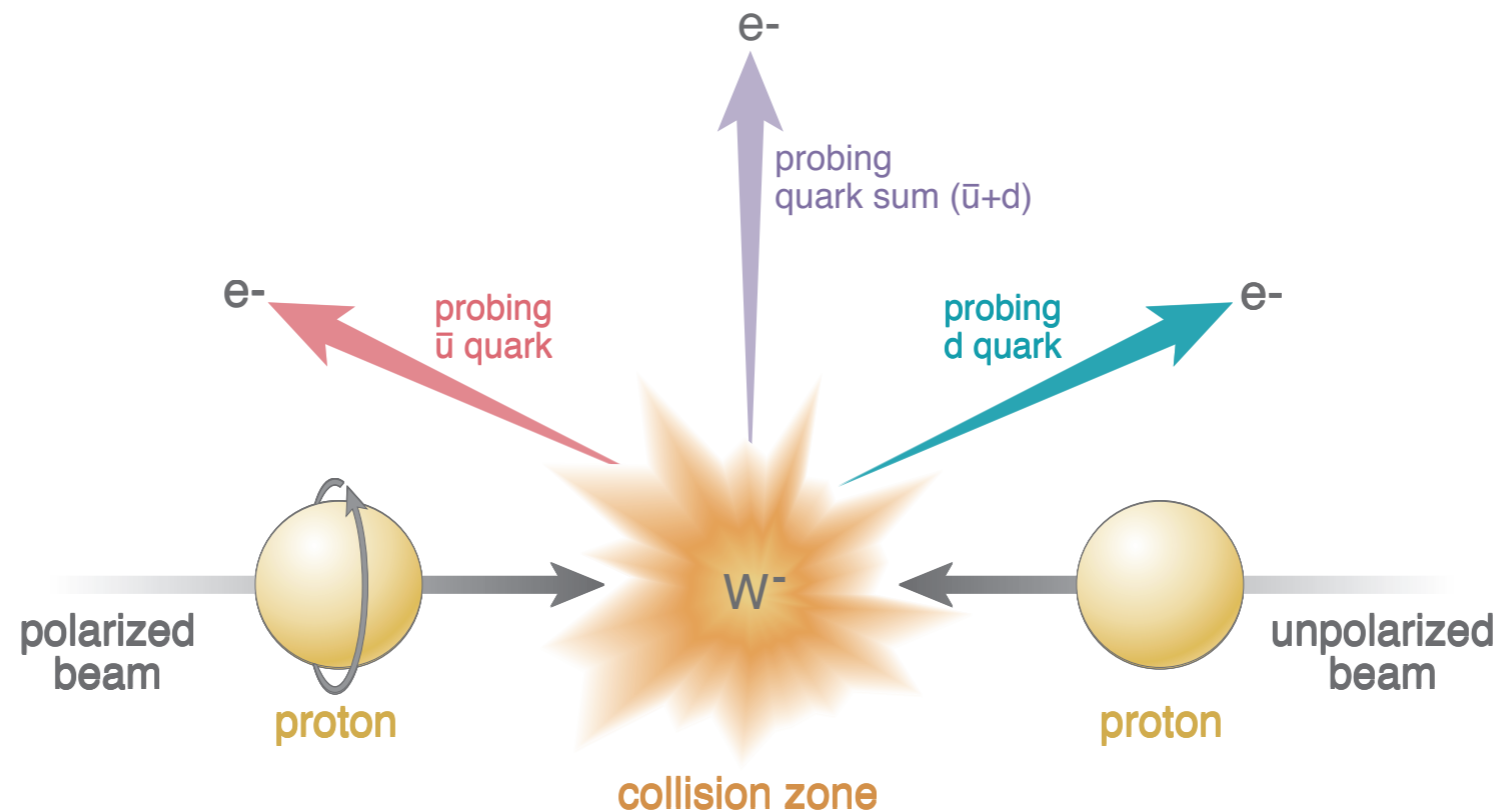

◆ Introduction /
Theoretical Aspects

◆ Experimental Aspects

◆ Recent Results /
Current Analysis

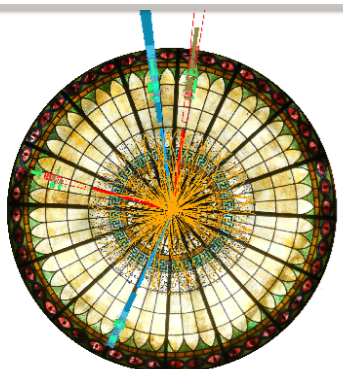

DIS 2015
XXIII International Workshop on
Deep-Inelastic Scattering and
Related Subjects
Dallas, Texas
April 27 – May 1, 2015

Devika Gunarathne
(for the STAR collaboration)
Temple University

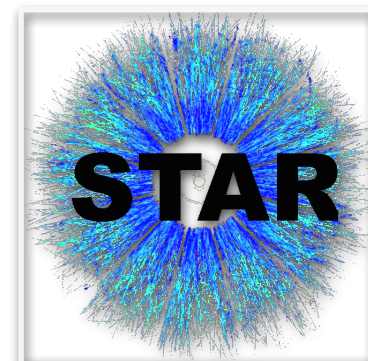

Evolving Picture of Proton's Spin Structure

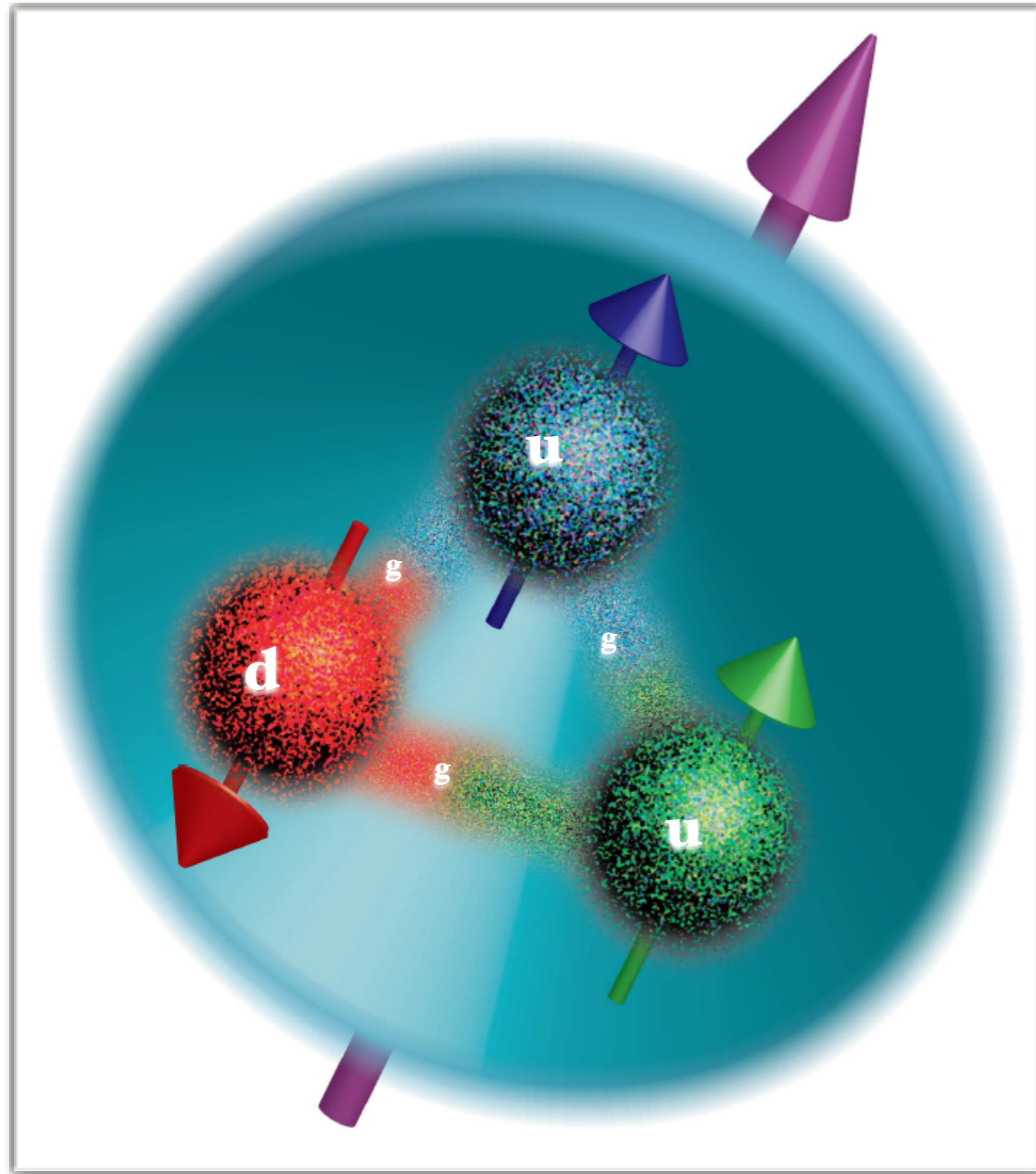

Valance Quarks

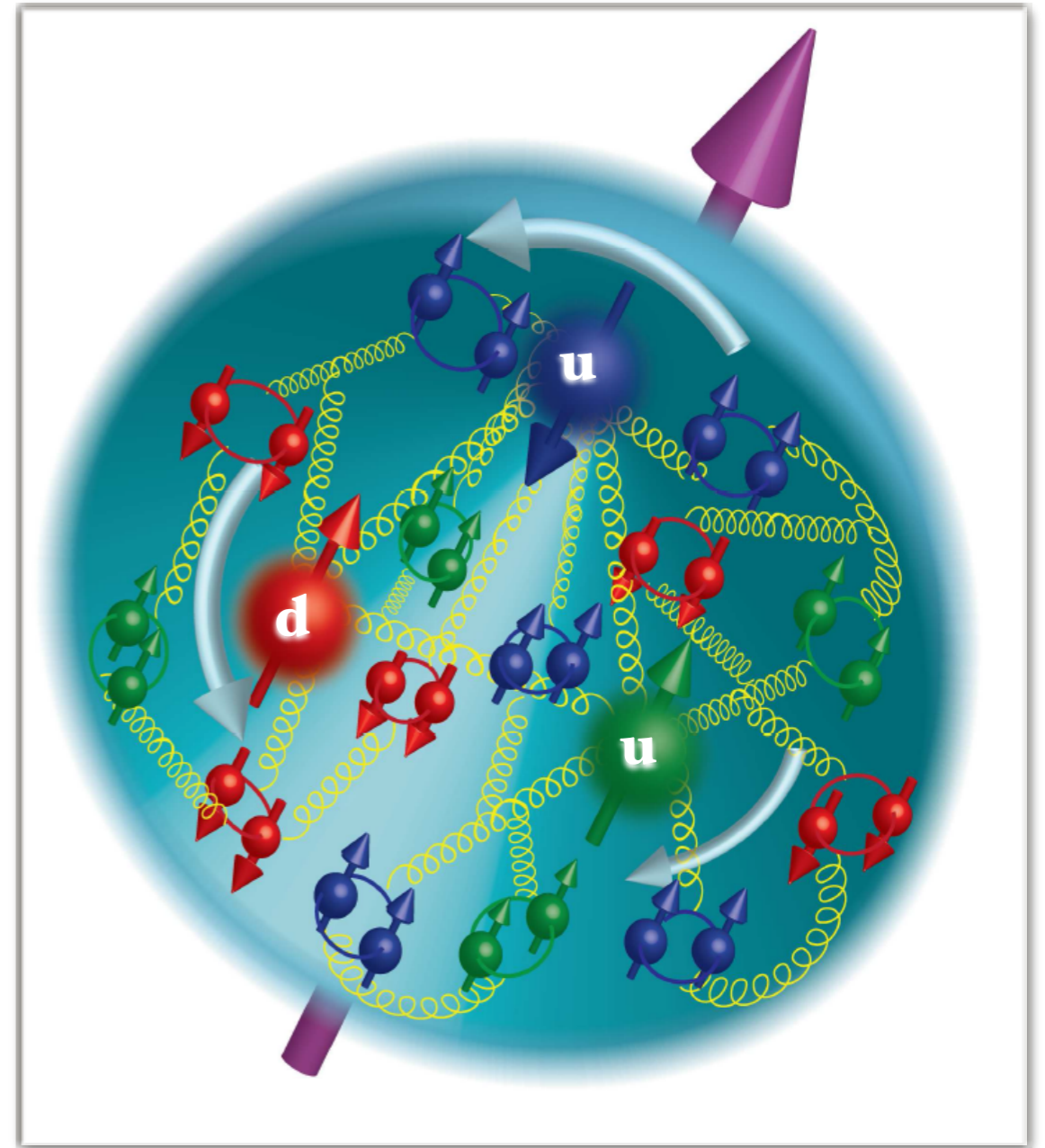
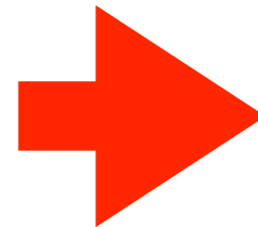

Sea Quarks

Anti Quark Polarization

Spin sum rule for longitudinally Polarized proton :

$$\langle S_p \rangle = \frac{1}{2} = \frac{1}{2} \Delta\Sigma + \Delta G + L$$

Jeffe and Monahar, 1990

$$\Delta\Sigma = \int (\Delta u + \Delta d + \Delta s + \Delta\bar{u} + \Delta\bar{d} + \Delta\bar{s}) dx$$

~30 % from polarized inclusive DIS

Helicity PDF

$$\Delta f(x, Q^2) \equiv f^+(x, Q^2) - f^-(x, Q^2)$$

DSSV Global Analysis

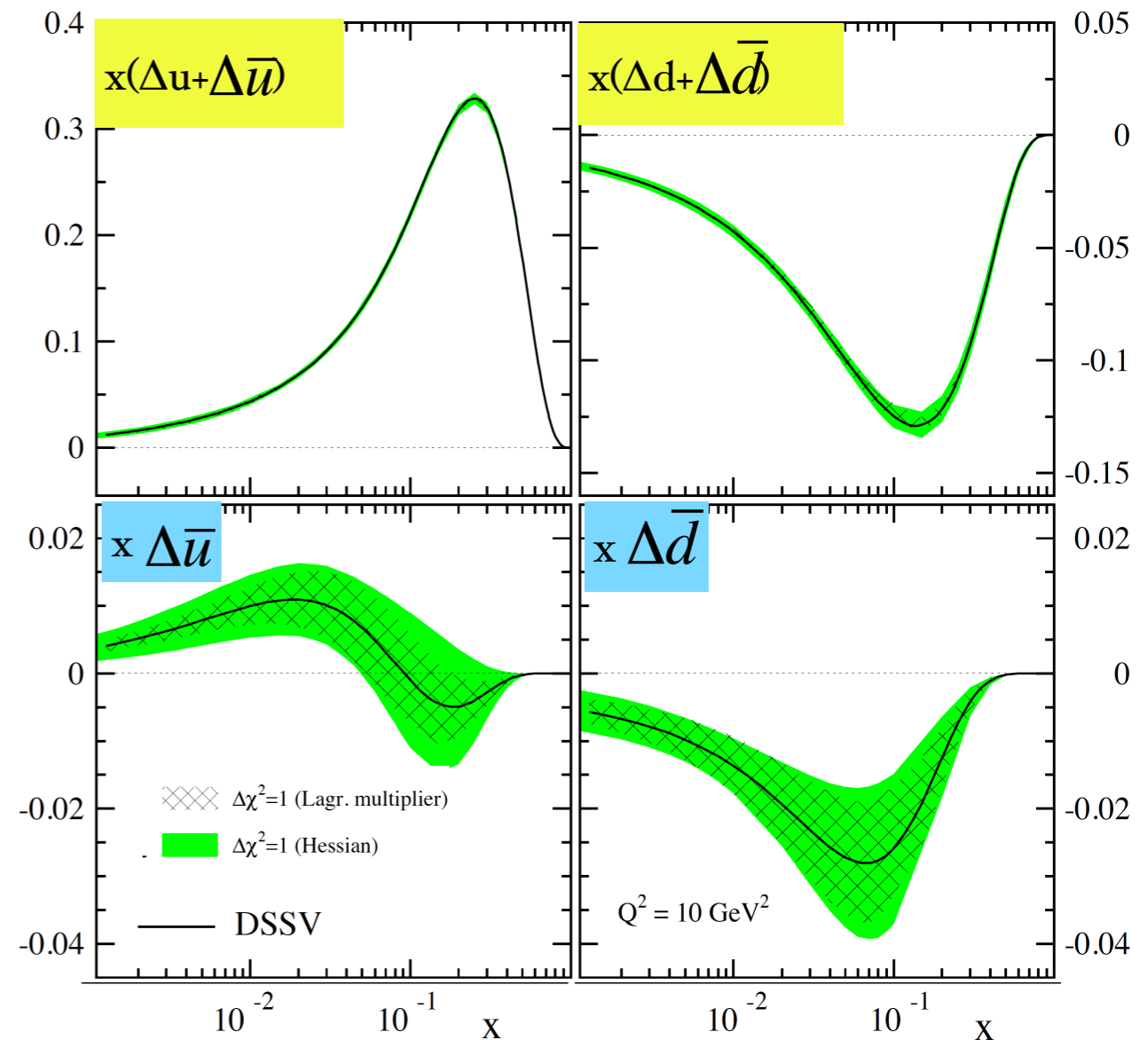

PRD 80, 034030(2009)

W Boson Production

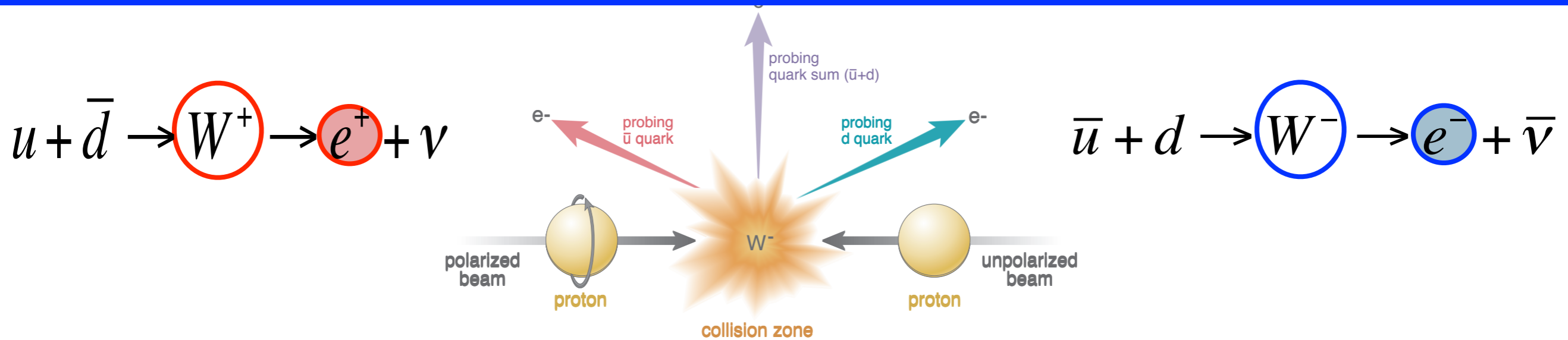

- ❖ **Direct Coupling** to the Quark and anti Quark of interest.
- ❖ Maximum **violation of parity** leads to perfect **spin separation**.

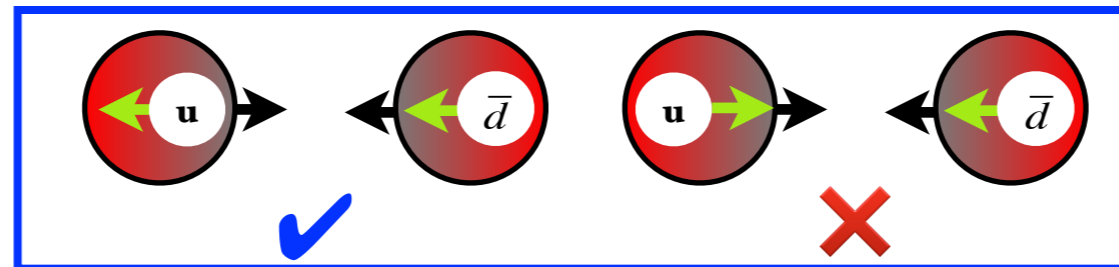

- ❖ **High** resolution scale (Q^2) set by the **W** mass.
- ❖ **Easy detection** via the **leptonic decay channels**.

Parity violating longitudinal
single spin asymmetry

$$A_L = \frac{\sigma^+ - \sigma^-}{\sigma^+ + \sigma^-}$$

W A_L : Theoretical Aspects

W A_L, highly sensitive to individual polarizations at forward and backward decay lepton pseudo rapidity (η_e)

$$\eta = -\ln\left(\tan\left(\frac{\theta}{2}\right)\right) \quad \langle x_{1,2} \rangle \sim \frac{M_W}{\sqrt{s}} e^{\pm\eta_e/2}$$

$$\eta \lll 0 \rightarrow x_1 \ll x_2, \theta \rightarrow \pi$$

$$A_L^{e^-} \approx \frac{\int_{\otimes(x_1, x_2)} [\Delta\bar{u}(x_1)d(x_2)(1 - \cos\theta)^2 - \Delta d(x_1)\bar{u}(x_2)(1 + \cos\theta)^2]}{\int_{\otimes(x_1, x_2)} [\bar{u}(x_1)d(x_2)(1 - \cos\theta)^2 + d(x_1)\bar{u}(x_2)(1 + \cos\theta)^2]}$$

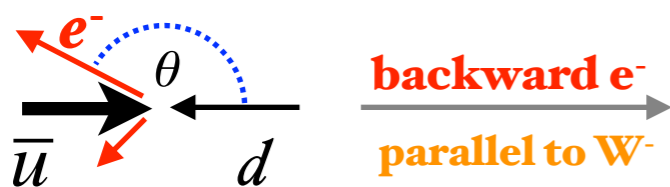

$$\frac{\Delta\bar{u}}{\bar{u}}$$

$$\eta \ggg 0 \rightarrow x_1 \gg x_2, \theta \rightarrow 0$$

$$A_L^{e^+} \approx \frac{\int_{\otimes(x_1, x_2)} [\Delta\bar{d}(x_1)u(x_2)(1 + \cos\theta)^2 - \Delta u(x_1)\bar{d}(x_2)(1 - \cos\theta)^2]}{\int_{\otimes(x_1, x_2)} [\bar{d}(x_1)u(x_2)(1 + \cos\theta)^2 + u(x_1)\bar{d}(x_2)(1 - \cos\theta)^2]}$$

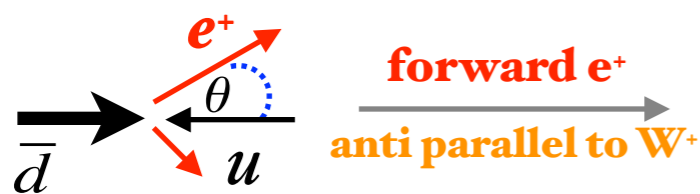

$$\frac{\Delta\bar{d}}{\bar{d}}$$

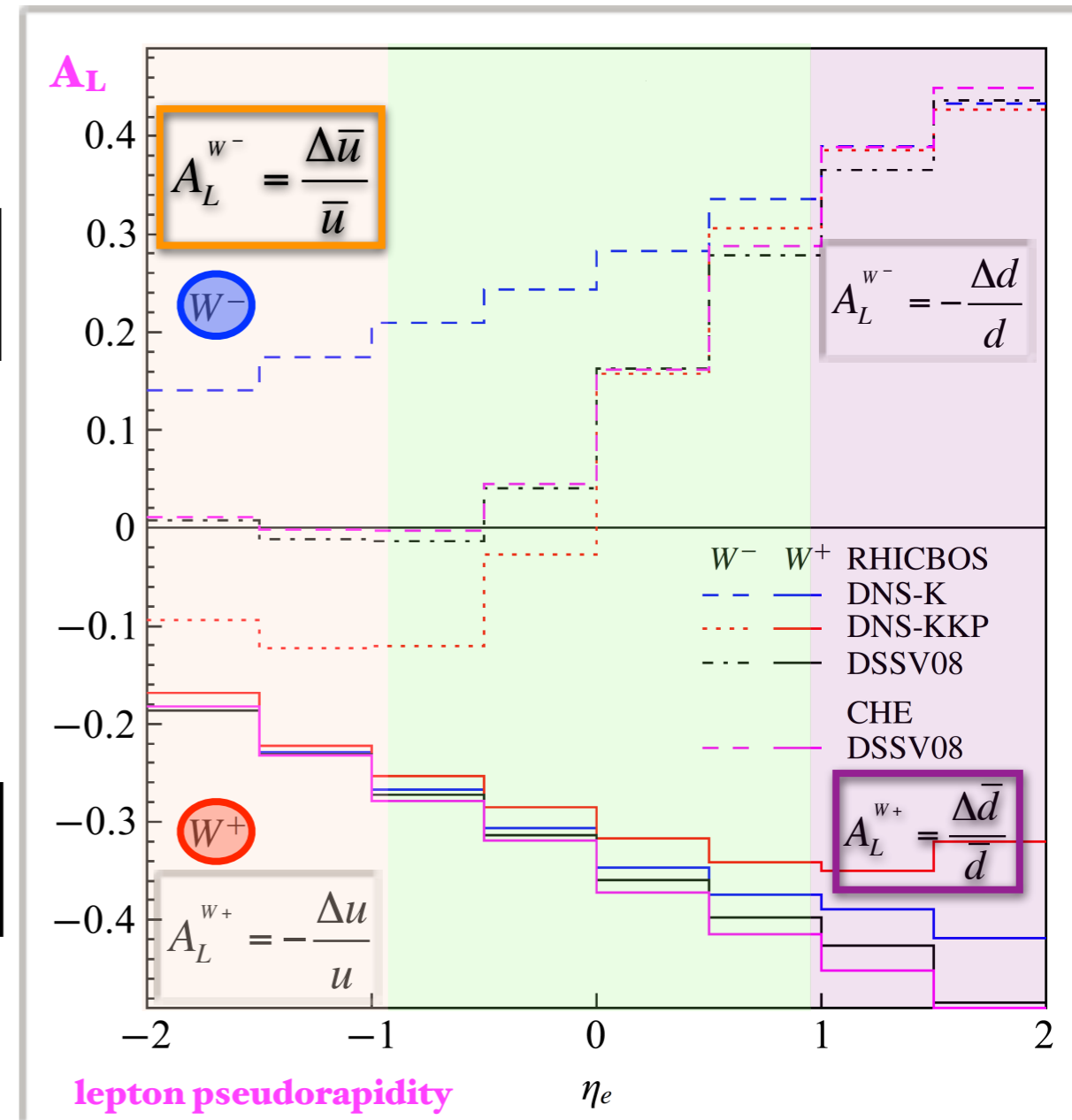

RHIC : Relativistic Heavy Ion Collider

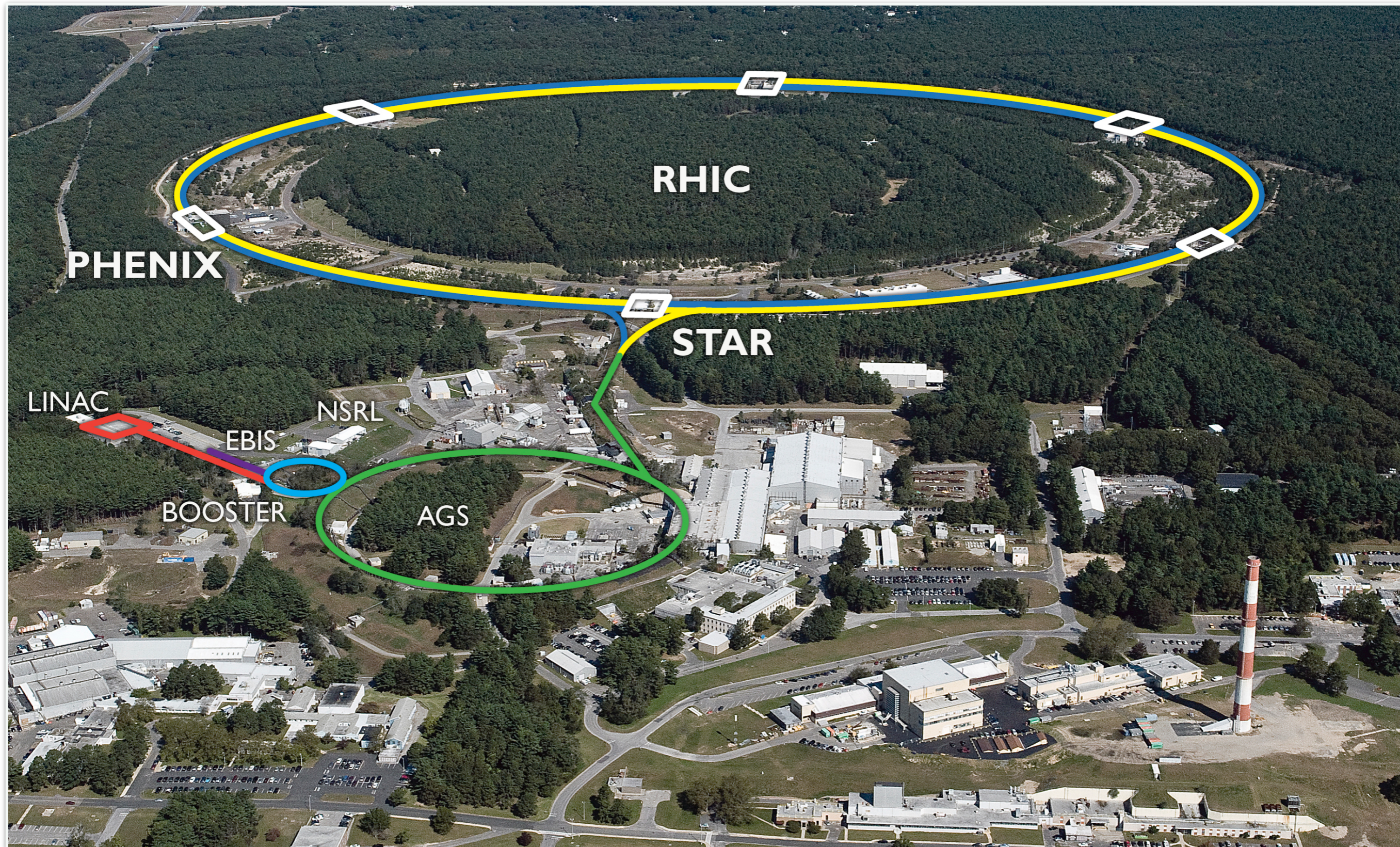

STAR Detector Overview

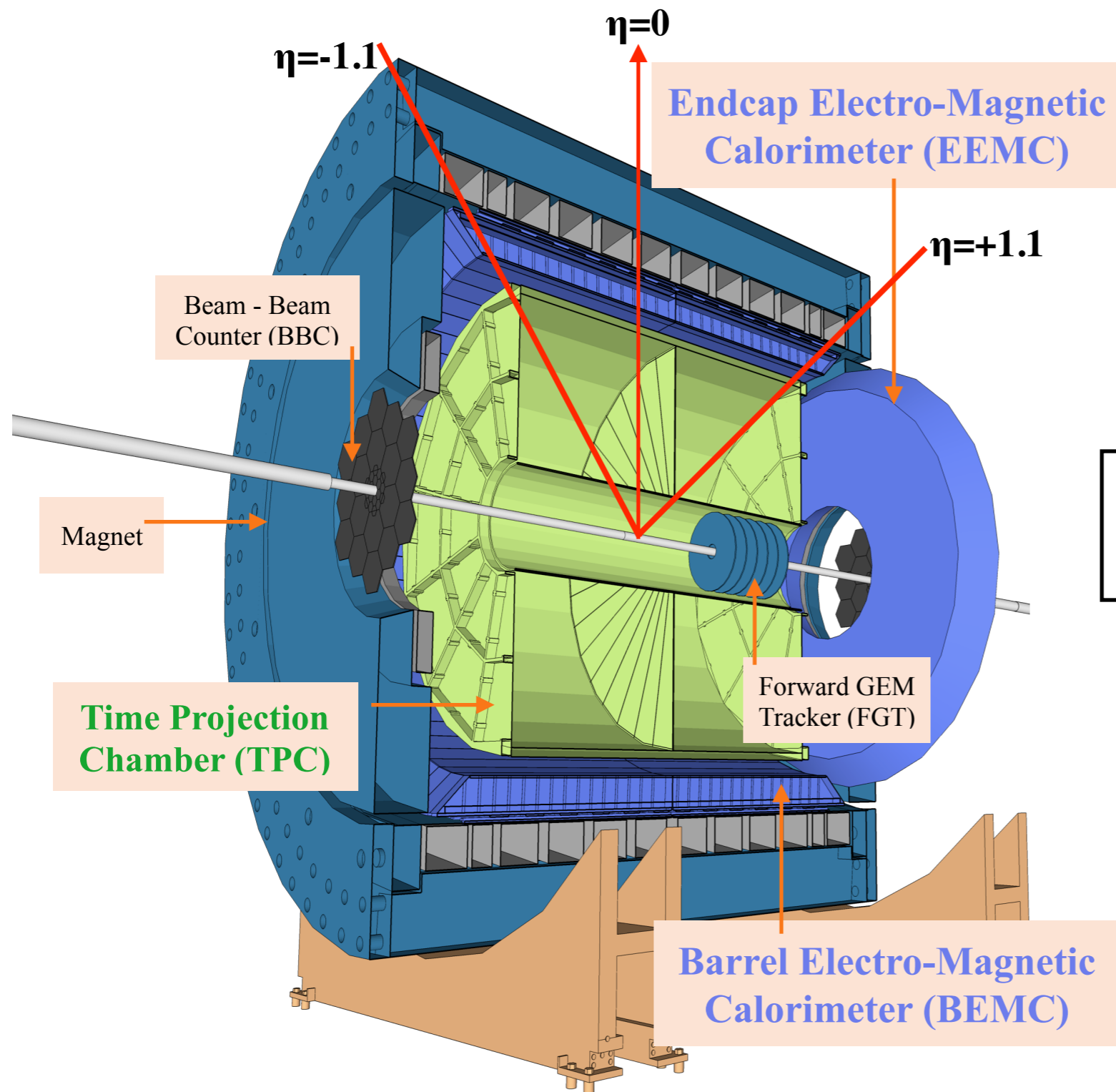

$$\eta = -\ln(\tan(\theta/2))$$

TPC: Charge particle tracking
BEMC, EEMC: EM Calorimetry

TPC : $-1.3 < \eta < +1.3$
BEMC : $-1.0 < \eta < +1.0$
EEMC : $+1.1 < \eta < +2.0$
FGT : $+1.0 < \eta < +2.0$

Year 2012

Mid-rapidity ($|\eta_{el}| < 1$) W Selection

W → e + ν candidate

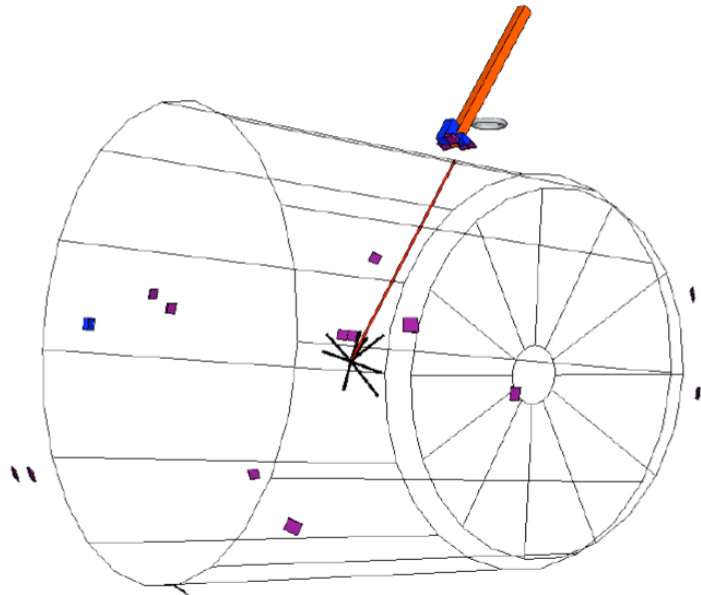

Isolated tracks → isolated EMC cluster
Large opposite missing “energy”

$P_T > 10$ GeV

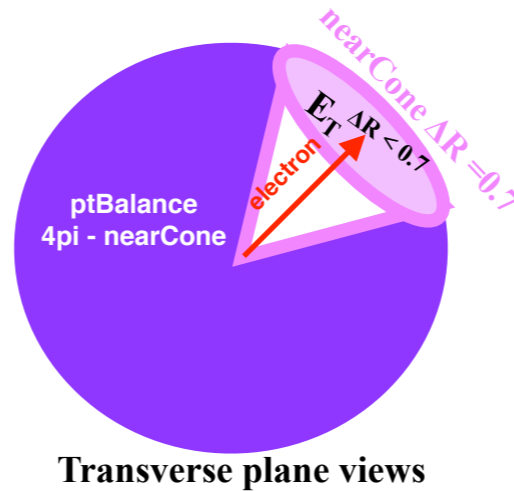

Transverse plane views

$$\vec{p}_T^{balance} = \vec{p}_T^e + \sum_{\Delta R > 0.7} \vec{p}_T^{jets}$$

$$signed P_T - balance = \frac{(\vec{p}_T^e \cdot \vec{p}_T^{balance})}{|\vec{p}_T^e|}$$

QCD background candidate

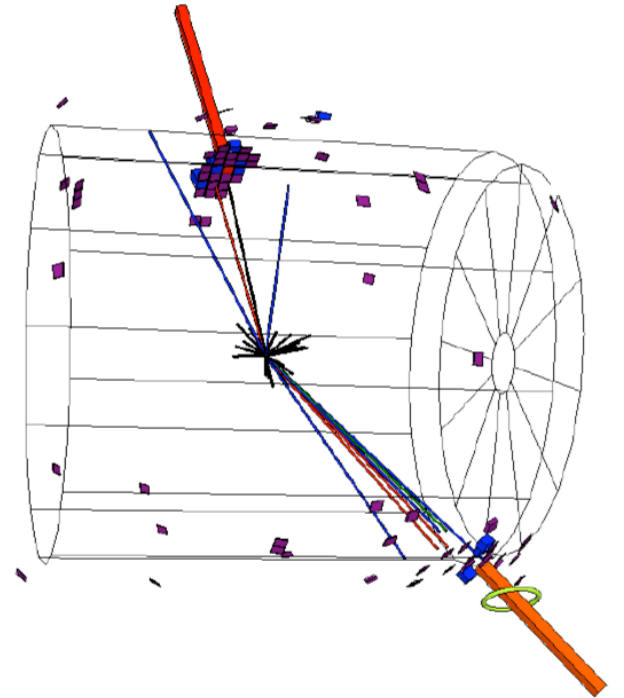

Several tracks → several EMC towers
No large missing “energy”

E_T distribution

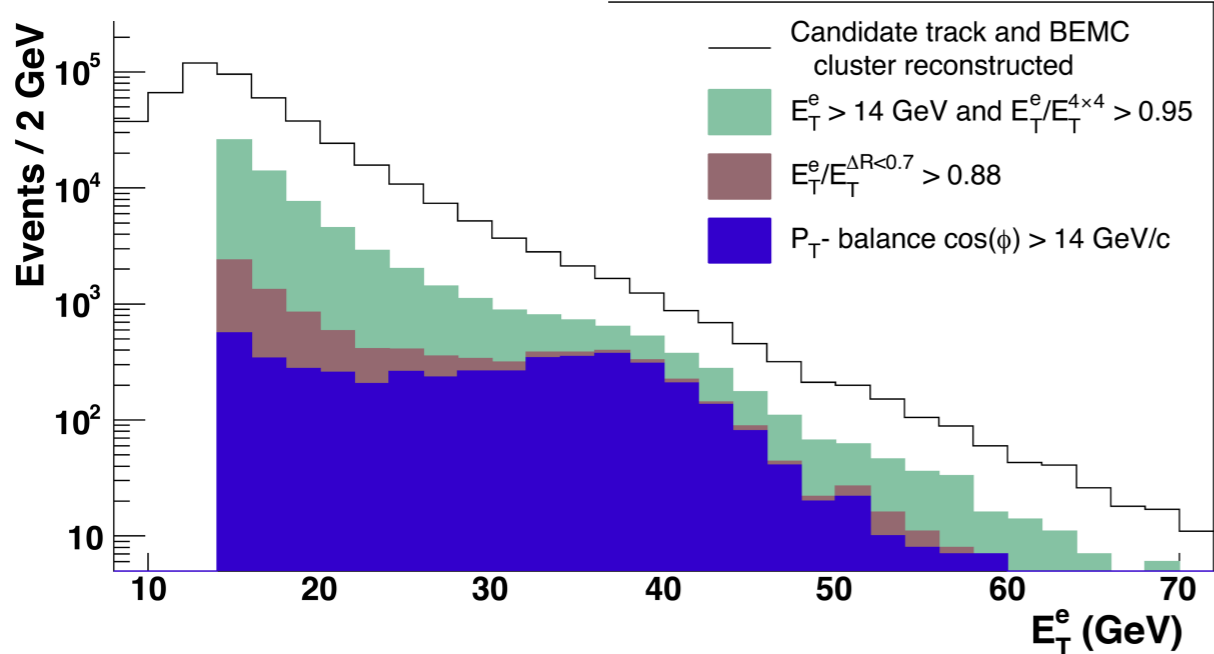

Sign- P_T balance

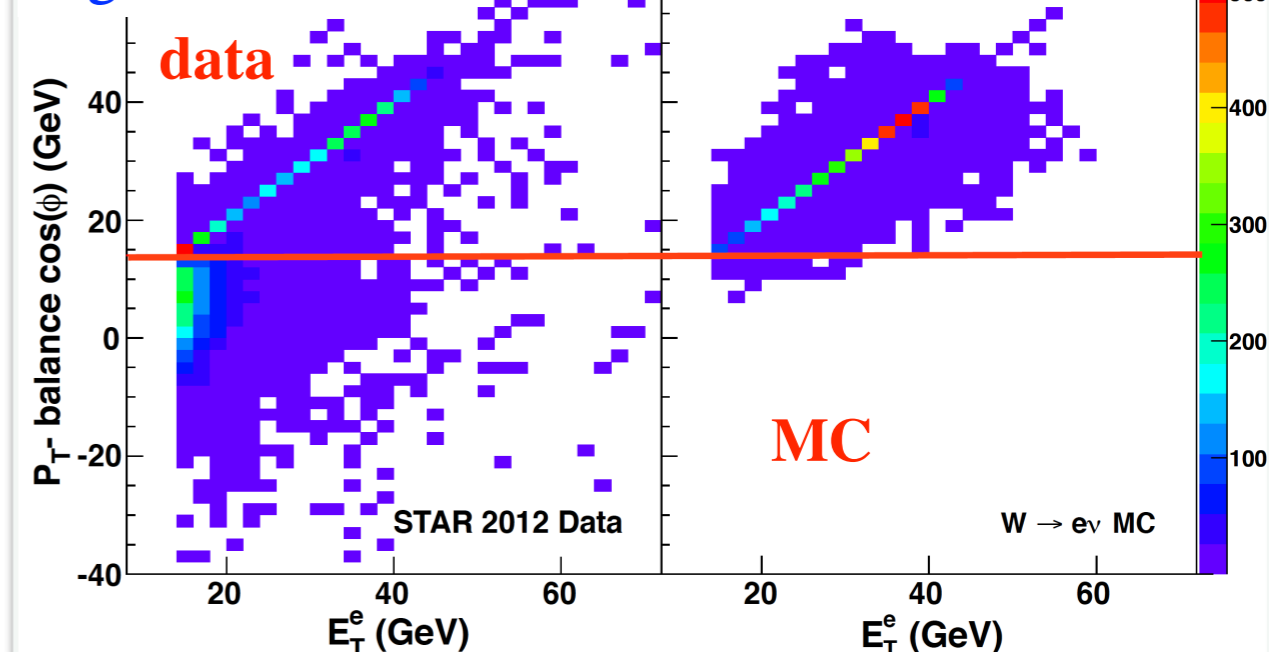

Mid-rapidity Background Estimation

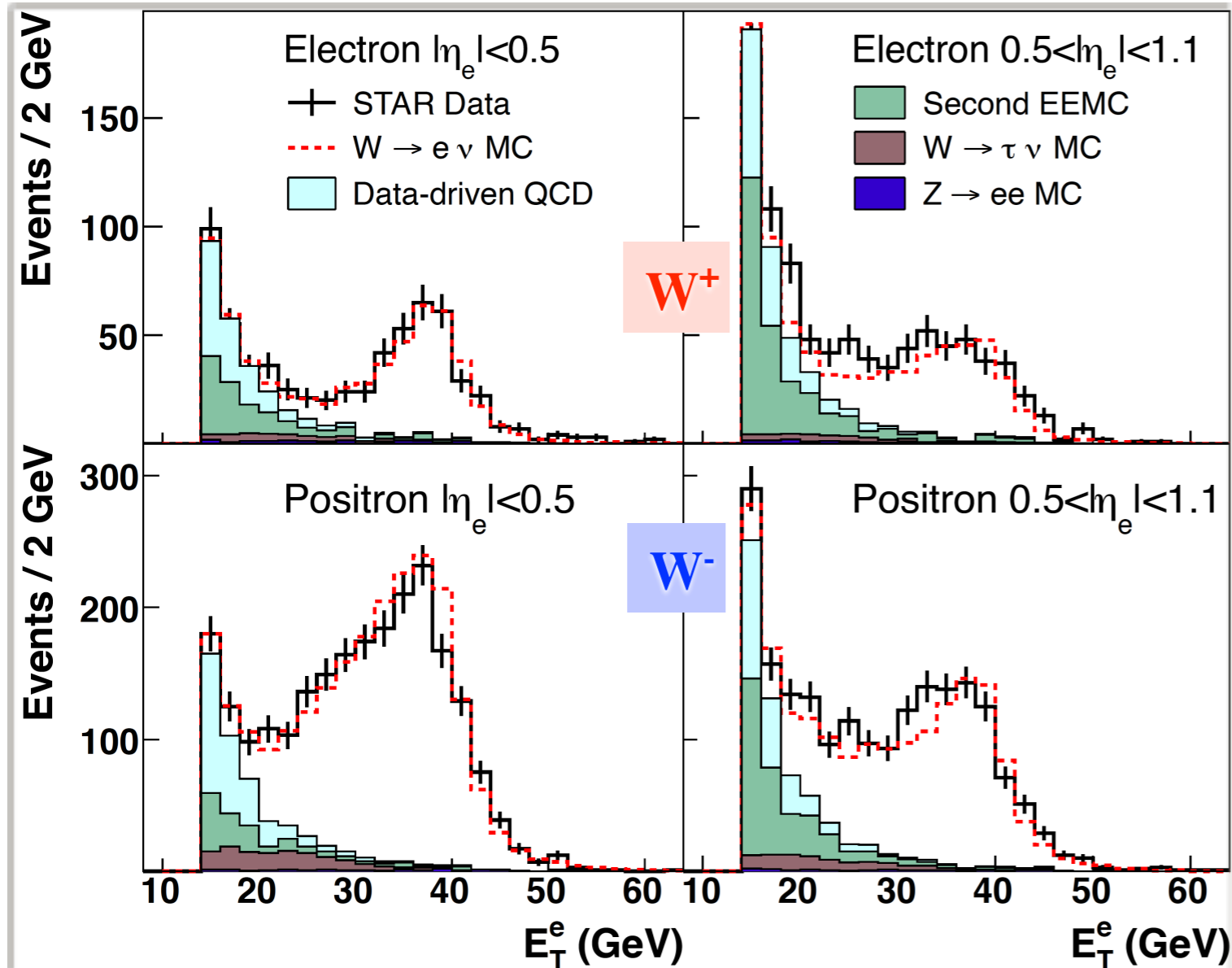

PRL 113,72301 (2014)

Primary Background

QCD processes where fragments of a jet satisfy candidate $e^{+/-}$ isolation cuts while **all other jets escape detection** outside the acceptance.

♣ **Second Endcap** $-2 < \eta < -1.09$

♣ **Data driven QCD** $|\eta| > 2$

Electroweak BG

♣ $W \rightarrow \tau \nu$ MC Embedded in Zero-bias events

♣ $Z \rightarrow e^+ e^-$

Forward rapidity ($1 < \eta_e < 1.4$) W selection uses similar technique as mid rapidity and **Background Estimation** improve using additional **Endcap Shower Maximum Detector (ESMD)**

Results

$W A_L(\eta_e)$ 2012+2011

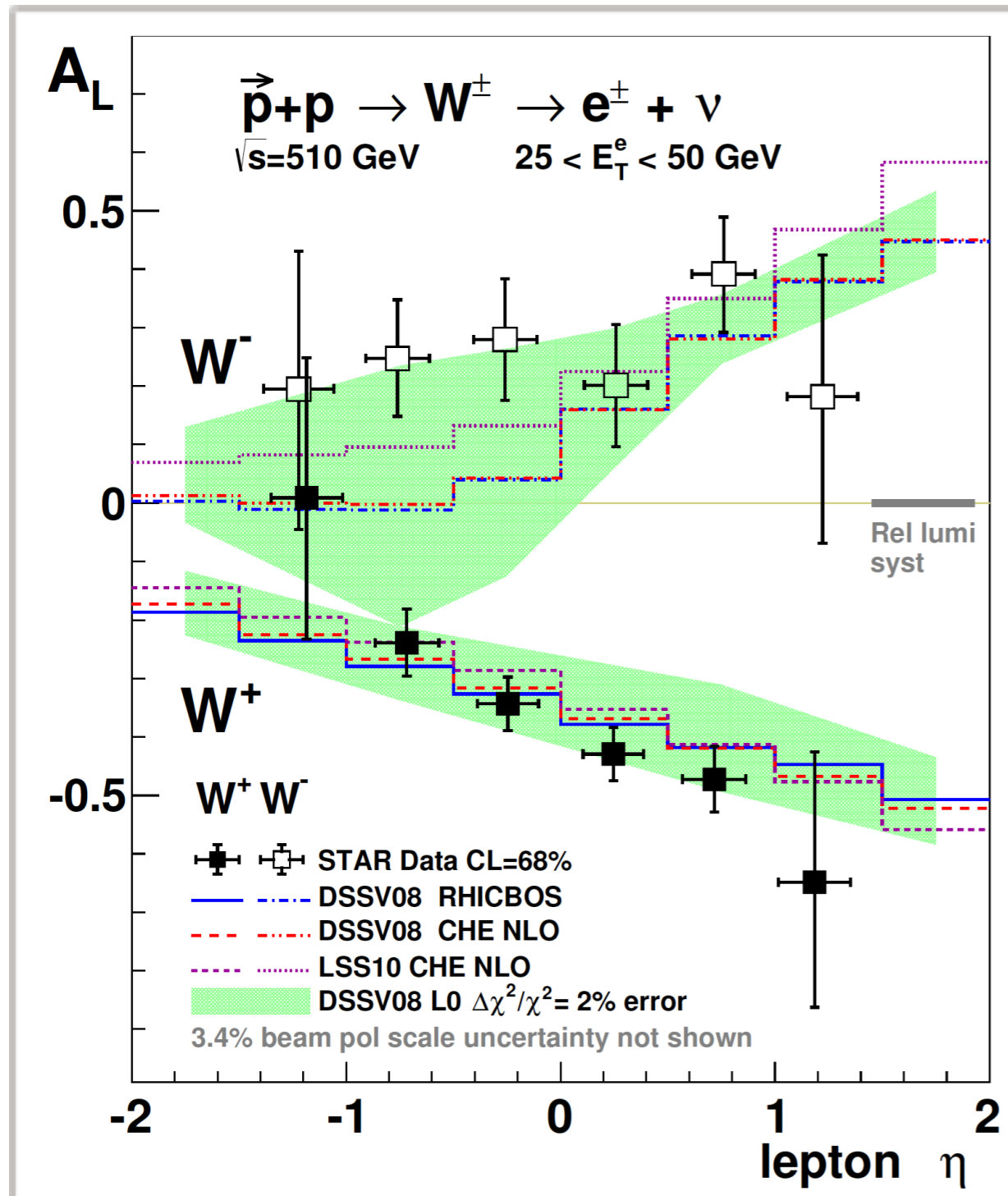

PRL 113,72301 (2014)

❖ **Profile Likelihood** method used to extract **Asymmetries** from combination of **2012** and **2011** data.

❖ **$A_L(W^-)$ is larger** than the DSSV Predictions.

◆ The enhancement at $\eta_e < 0$, in particular is sensitive to the $\Delta\bar{u}$, polarized **antiquark distribution**.

❖ **$A_L(W^+)$ is consistent** with **theoretical predictions** using the DSSV polarized PDFs.

❖ The **Systematic uncertainties** for A_L are well **under control** for $|\eta_e| < 1.4$.

Impact on Recent Global Analysis

- ❖ Preliminary Global analysis (**DSSV++**) from DSSV group and recent **NNPDF** includes preliminary **STAR 2012 W A_L** data.
- ❖ **Shift** in central value for $\Delta\bar{u}$ (negative -> positive) and $\Delta\bar{d}$ due to A_L W from STAR .
- ❖ **STAR 2012 W** results provide significant constraints on anti u and anti d quark polarization.

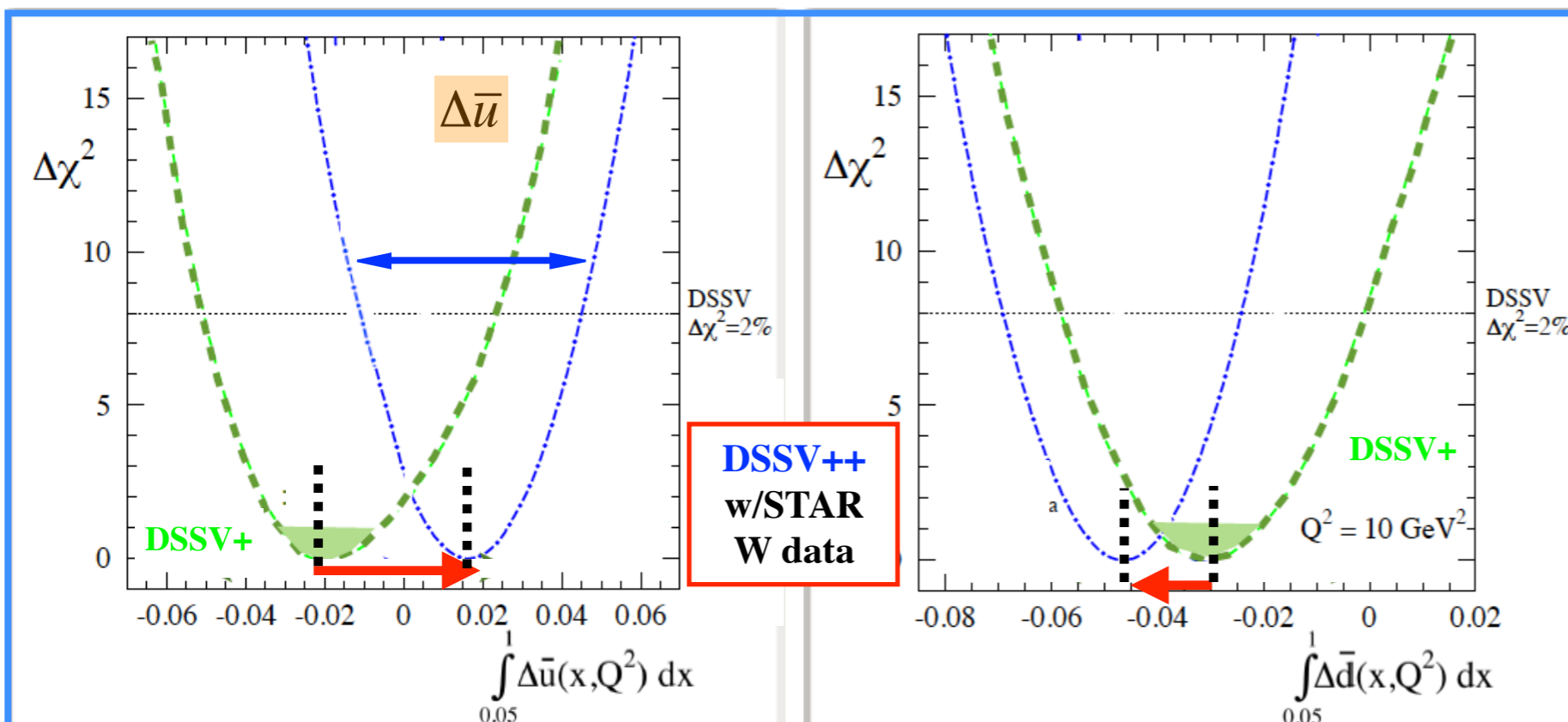

arXiv: 1304.0079

arXiv: 1304.0079

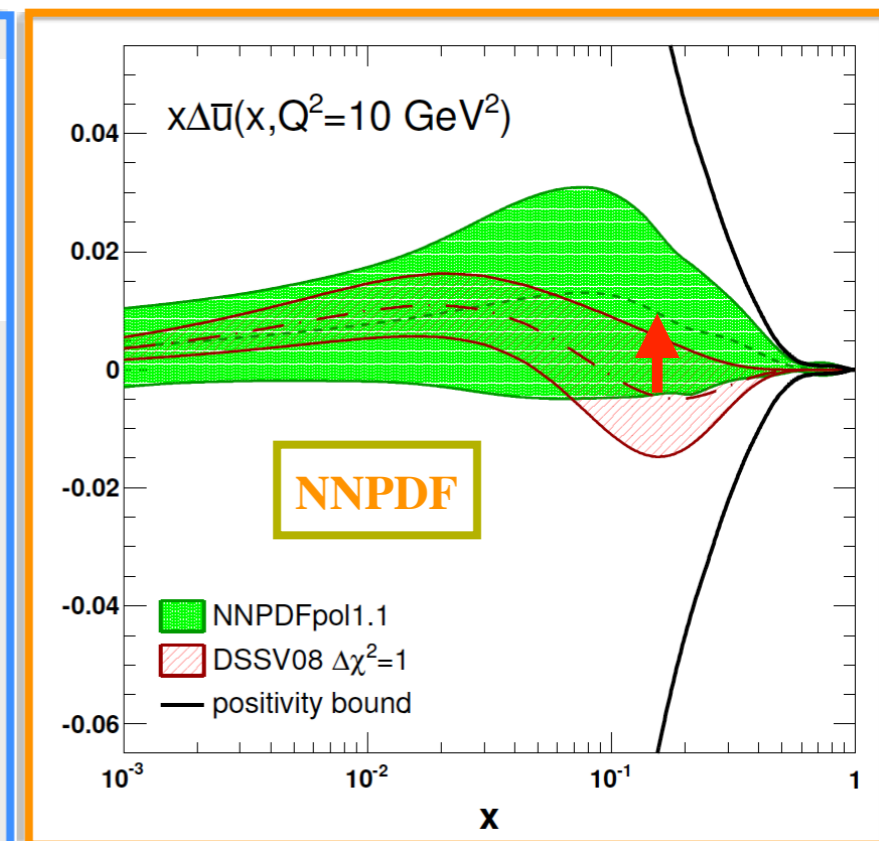

arXiv: 1403.0440

STAR 2013 W Analysis Status

2013 Data Sample

Barrel EMC triggered Integrated Luminosity

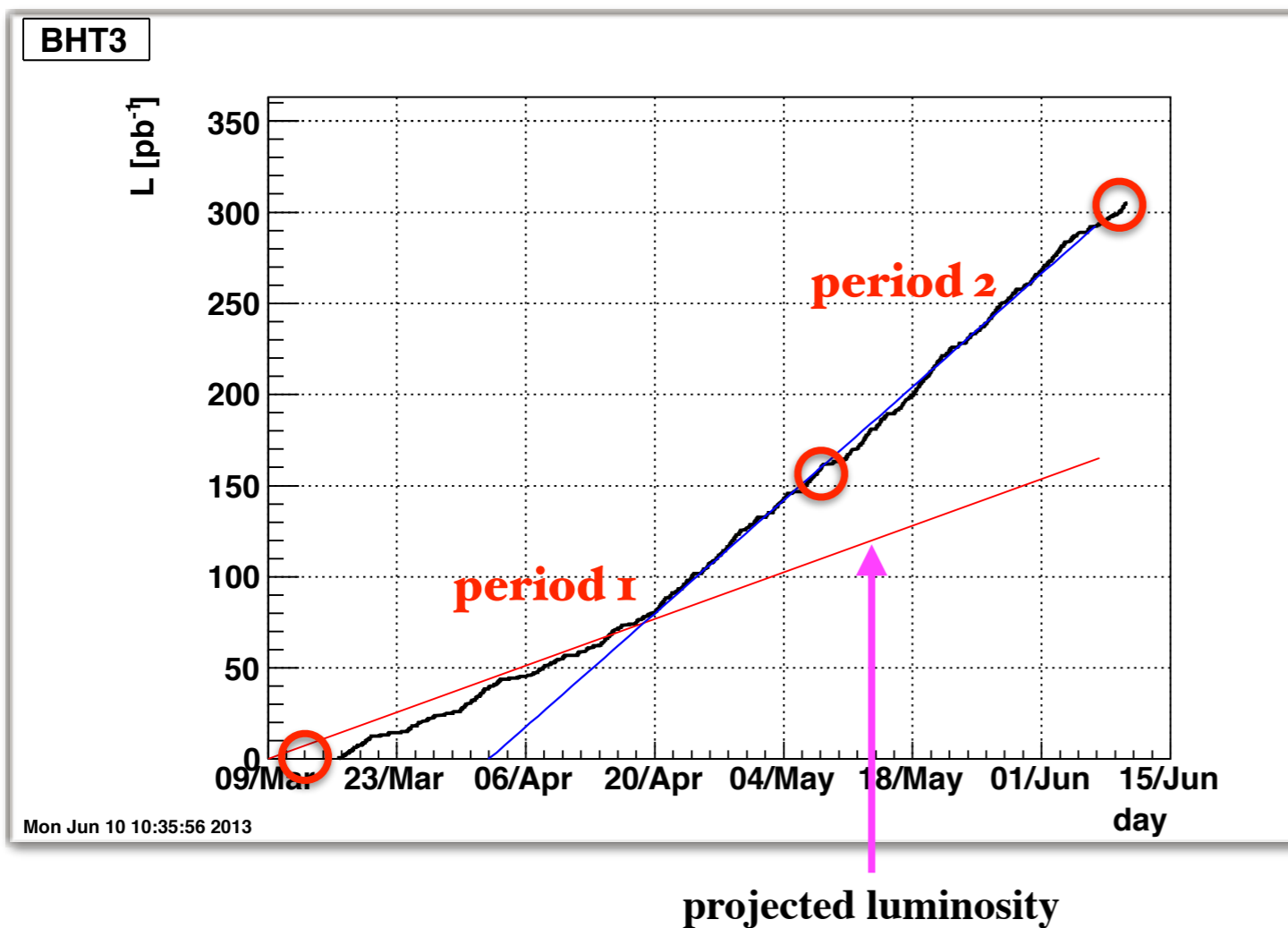

	L (pb^{-1})	P	FOM (P^2L (pb^{-1}))
Run 9	12	0.38	1.7
Run 11	9.4	0.49	2.3
Run 12	72	0.56	24
Run 13	~ 300	0.54	~ 87

In 2013 STAR collected total integrated luminosity of $\sim 300 \text{ pb}^{-1}$ at $\sqrt{s} = 500 \text{ GeV}$ with an average beam polarization of $\sim 54\%$.

Detector Calibration

♣ TPC

♣ **Charge Sign reconstruction** is based on bending of TPC tracks in the presence of magnetic field.

♣ Challenging environment of **charge-sign discrimination at high-pT using TPC in high luminosity / pile-up operation** - **Very careful TPC calibration required!!!!**

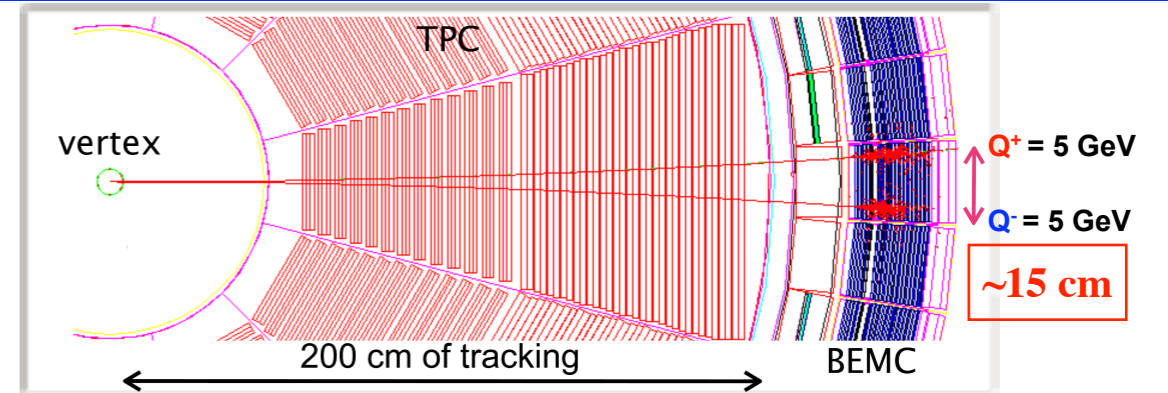

global TPC tracks

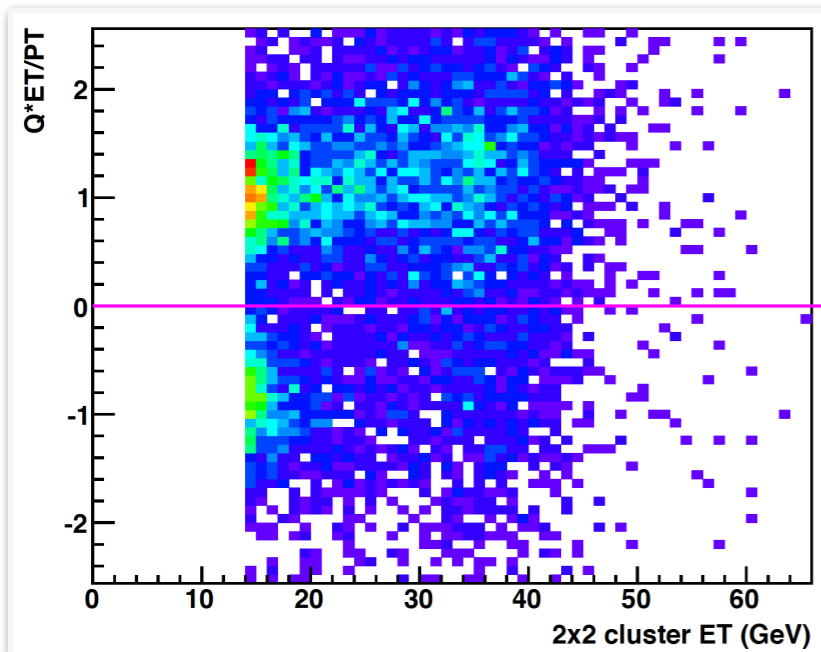

W candidate tracks

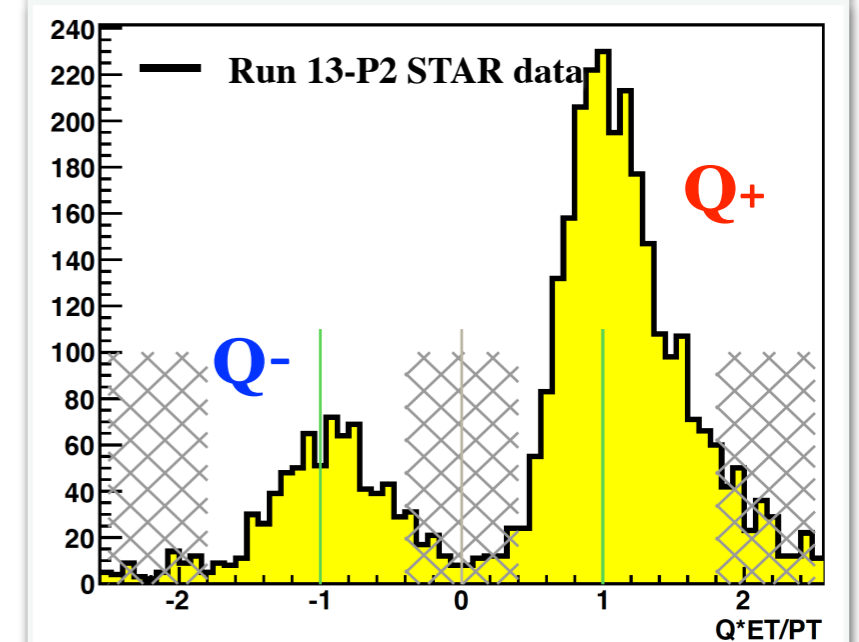
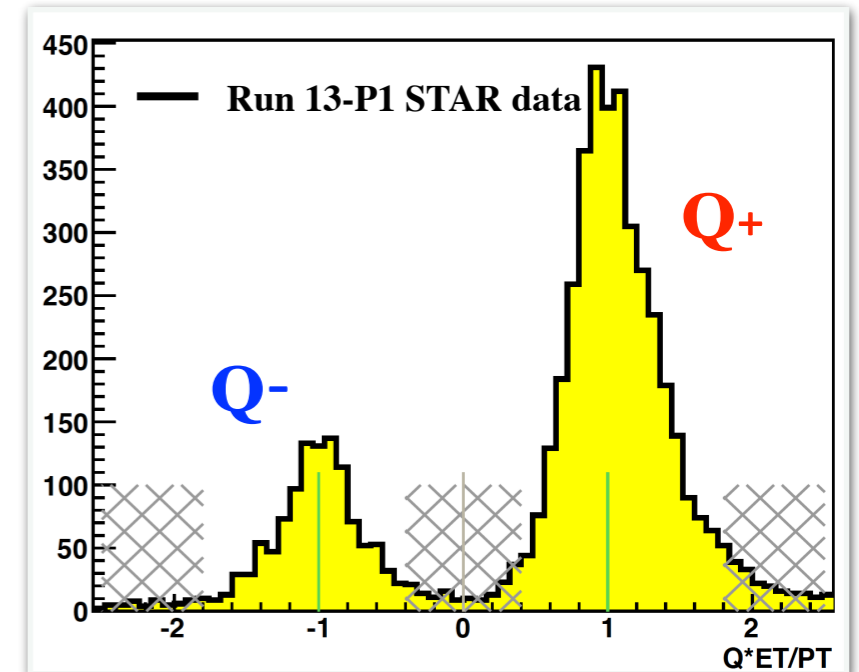
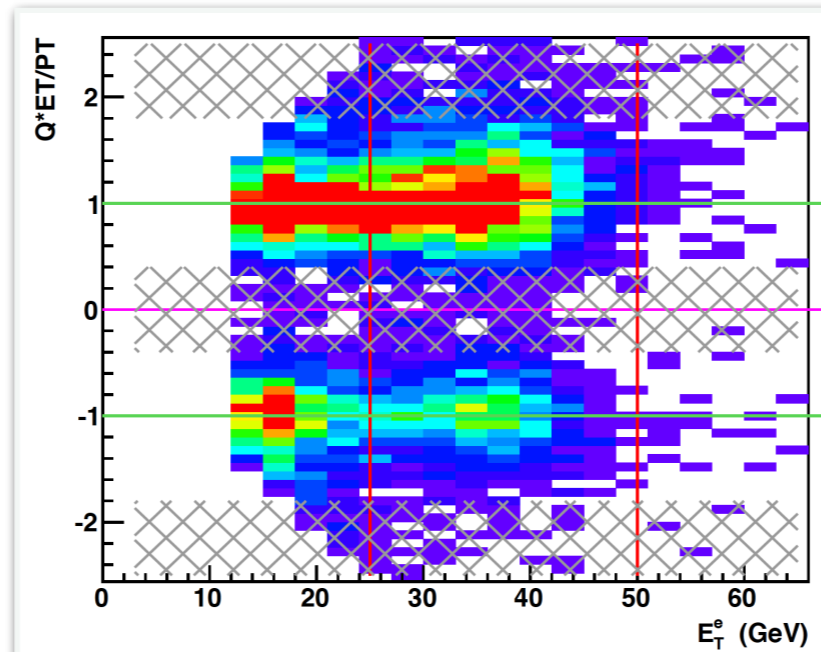

Detector Calibration

❖ BEMC

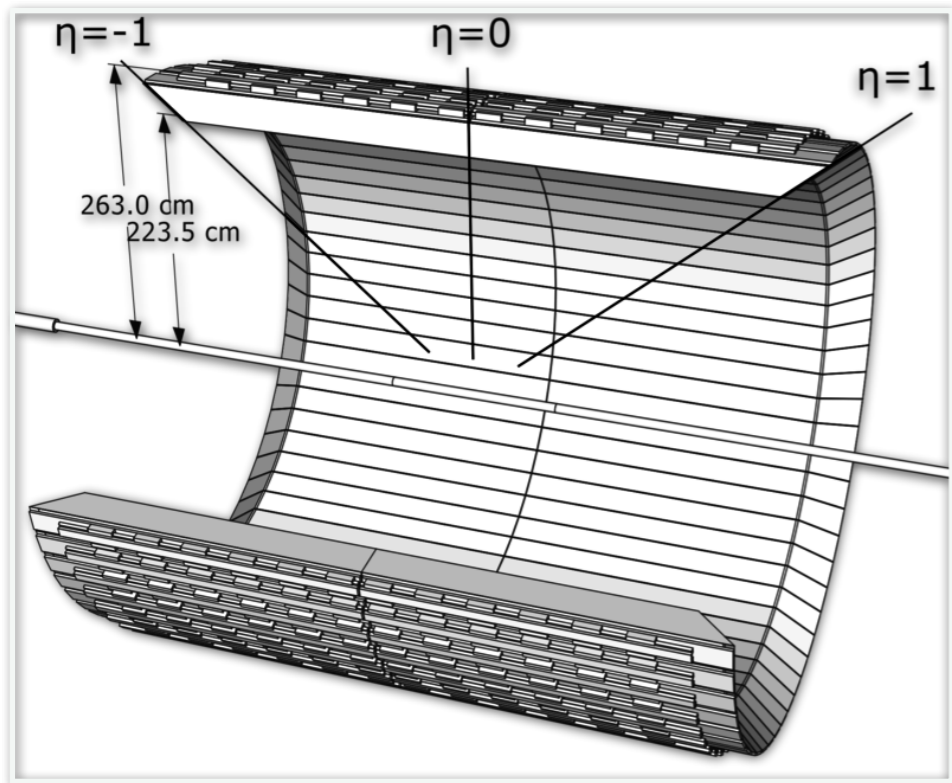

❖ BEMC is a sampling calorimeter and it is segmented into 4800 towers, each with $\Delta\eta \times \Delta\phi = 0.05 \times 0.05$

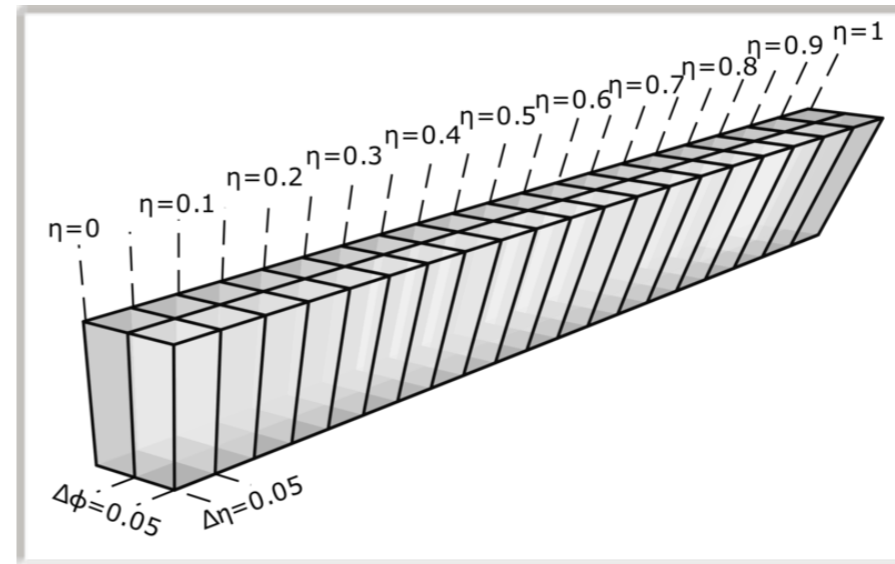

The geometry of the calorimeter towers in a BEMC module

Calibration need to be done considering all possible Energy ranges !!!

- ❖ In the low energy range **relative Calibration of towers** is done using abundant **MIPs (high P hadrons)**
- ❖ **E/P from electrons** is used to obtain **absolute calibration**.
- ❖ Other **High Energy probes** (from rare processes) such as **Z invariant mass peak position**, **slope of the sharp drop of W jacobian peak** will be used to calibrate in the high energy range.

Forward-rapidity Analysis Status :

FGT (Forward Gem Tracker)

W Charge-sign Separation using FGT

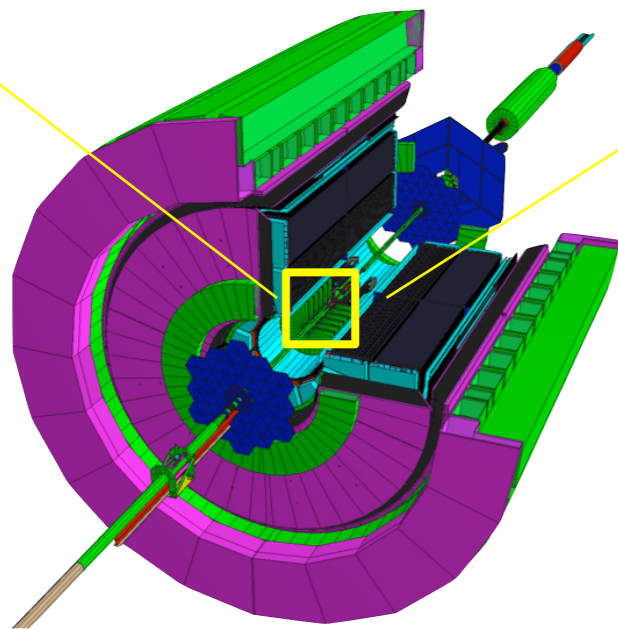
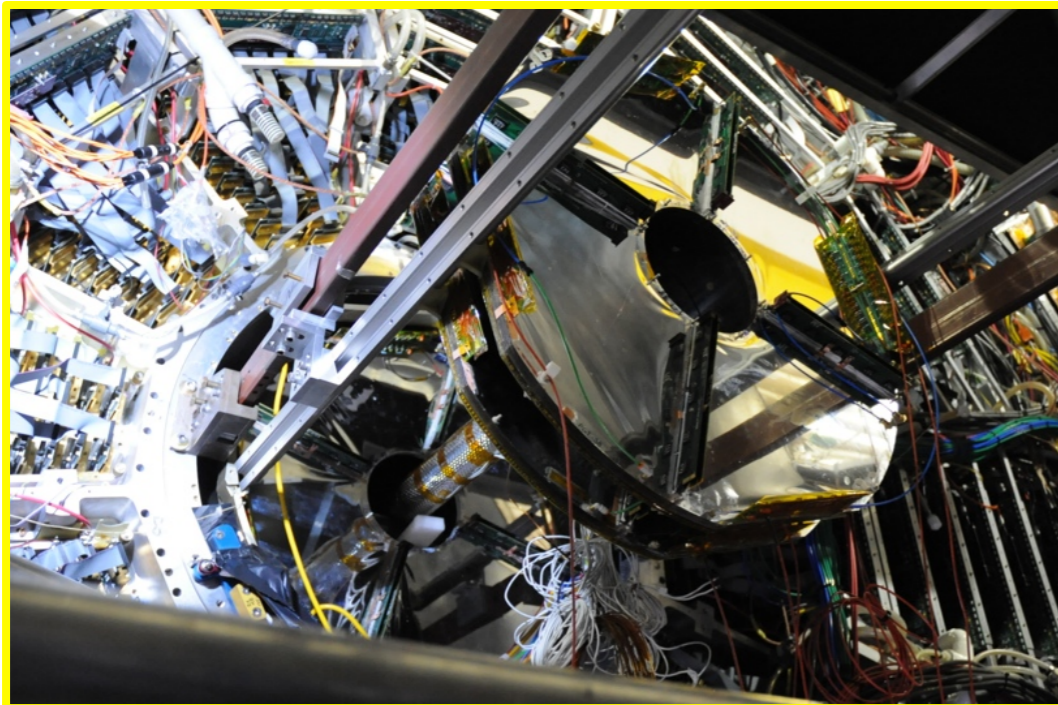

FGT($2 \geq \text{hits}$)+Vertex+EEMC+Prompt

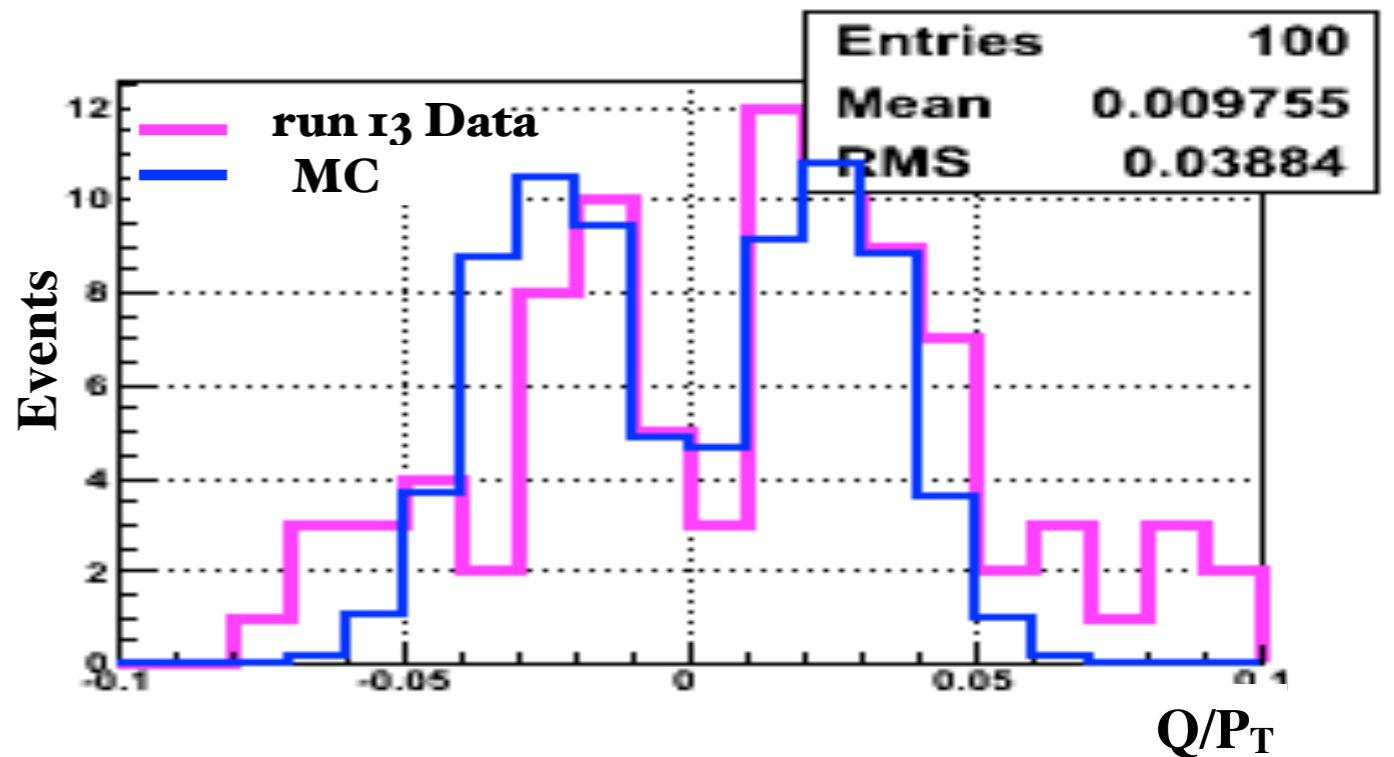

Prompt = actual measurement using TPC internal Multi-Wire proportional chamber

~2.5 sigma separation with FGT+VTX+EEMC
+PROMPT (~1/3 events)

STAR 2013 W A_L Projections

STAR W A_L Projections

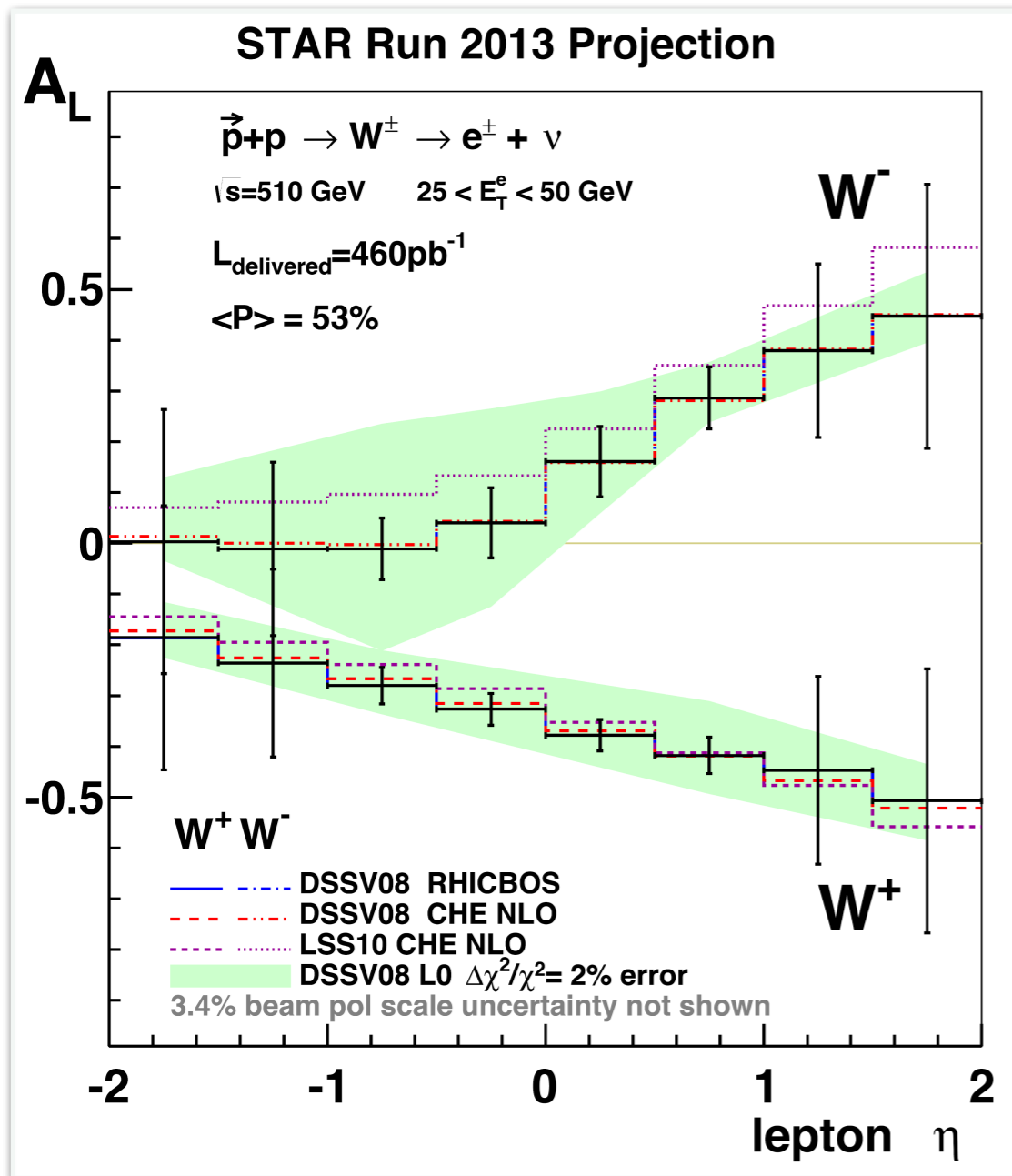

Higher precision results are expected from much larger statistics

Extension of forward and backward acceptance enhances sensitivity to \bar{u} and \bar{d} quark polarization

Impact on antiquark polarization

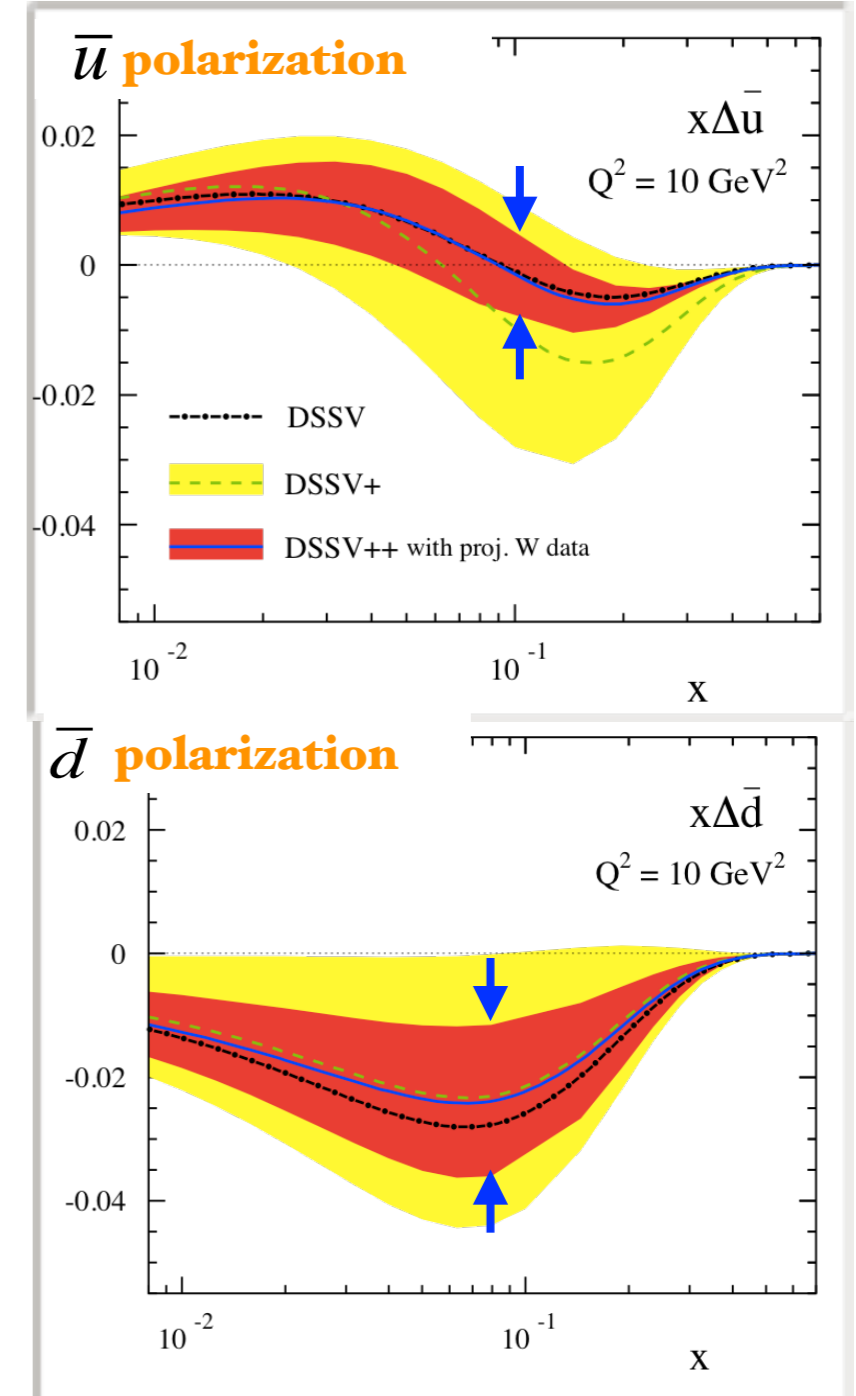

arXiv: 1304.0079

Summary / Outlook

- ◆ **The Production of W boson in polarized P+P collisions provides a new means to study the spin and flavor asymmetries of the proton sea quark distribution.**
- ◆ **STAR has measured the parity violating single spin asymmetry A_L for $|\eta_e| < 1.4$ from 2012 and 2011 data, providing the first detailed look at the asymmetries η_e dependence.**
- ◆ **STAR 2012 W A_L results provide significant constraints on anti u and anti d quark polarization.**
- ◆ **Large statistics of STAR Run 2013 is being analyzed now in mid-rapidity region ($|\eta| < 1$) and will use the 510 GeV Barrel EM calorimeter calibration which is in progress.**
- ◆ **Run 2013 analysis will be extended up to $\eta = 1.4$ utilizing the EEMC in the forward region and then very forward region using the FGT as the tracking device requiring completion of careful calibration of EEMC and FGT.**
- ◆ **High precision results from 2013 will improve the constraints on the sea quark polarization.**

Backup

systematic uncertainties

- Beam polarization uncertainty: correlated scale 3.4%
- Relative luminosity uncertainty: correlated offset $\Delta A_L = 0.007$
- Background estimation: less than 10% of statistical error

unpolarized BG β

betaP_2011

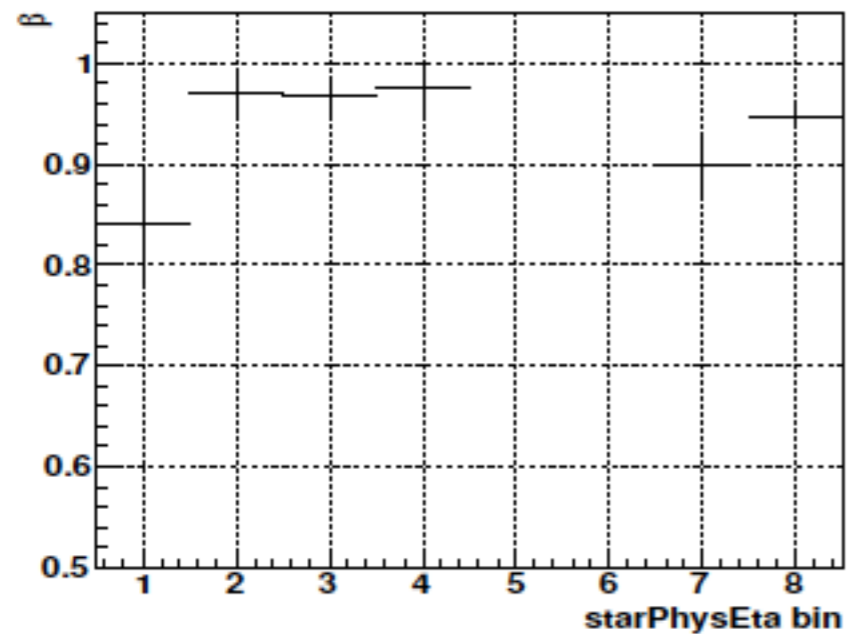

betaN_2011

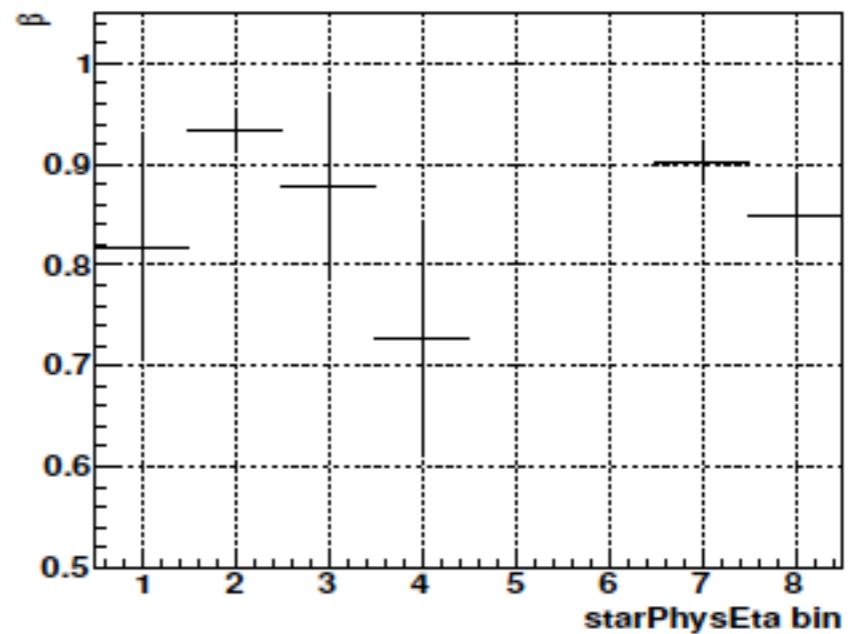

betaP_2012

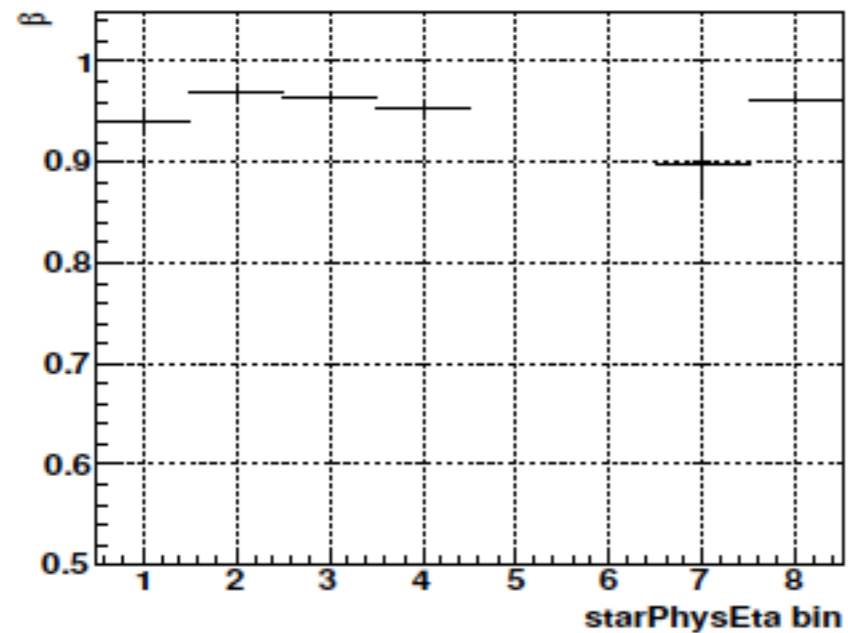

betaN_2012

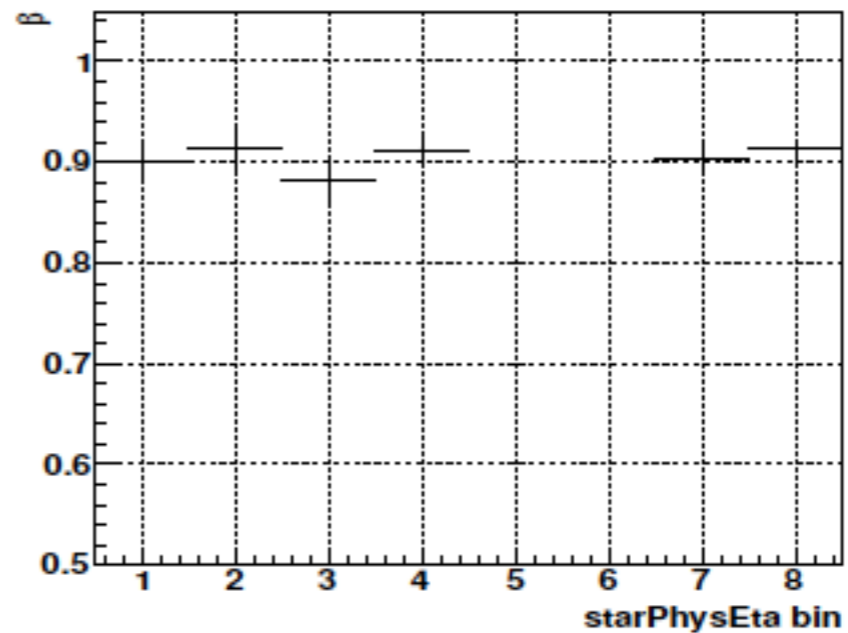

$$W^+ \beta: \sim 0.95, W^- \beta: \sim 0.9$$

where $\beta = S/(S + B)$, S and B are the number of signal and background events in [25, 50] GeV

STAR 2009 W Results

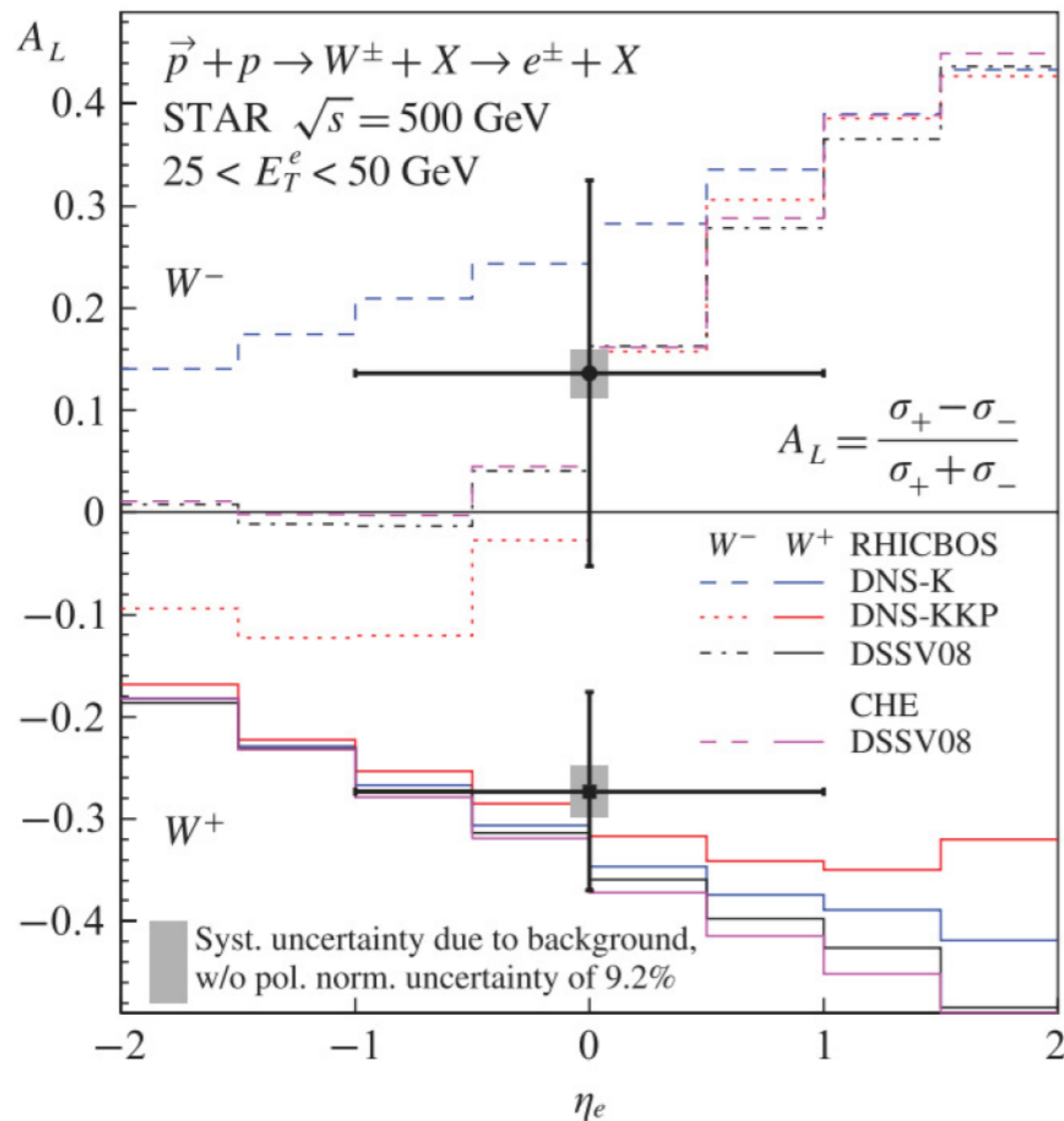

STAR pp500 Longitudinal		
Run	L (pb^{-1})	$W^+(W^-)$ raw yield
2009	12	462 (192)
2011	9	342 (103)
2012	77	2417 (734)

PRL 106, 062002 (2011)



Recent results - Quark / Anti-quark pol. program

Impact of new DSSV result

D. de Florian et al., Phys. Rev. Lett. 101 (2008)

RHIC Spin Collaboration (2012)

072001

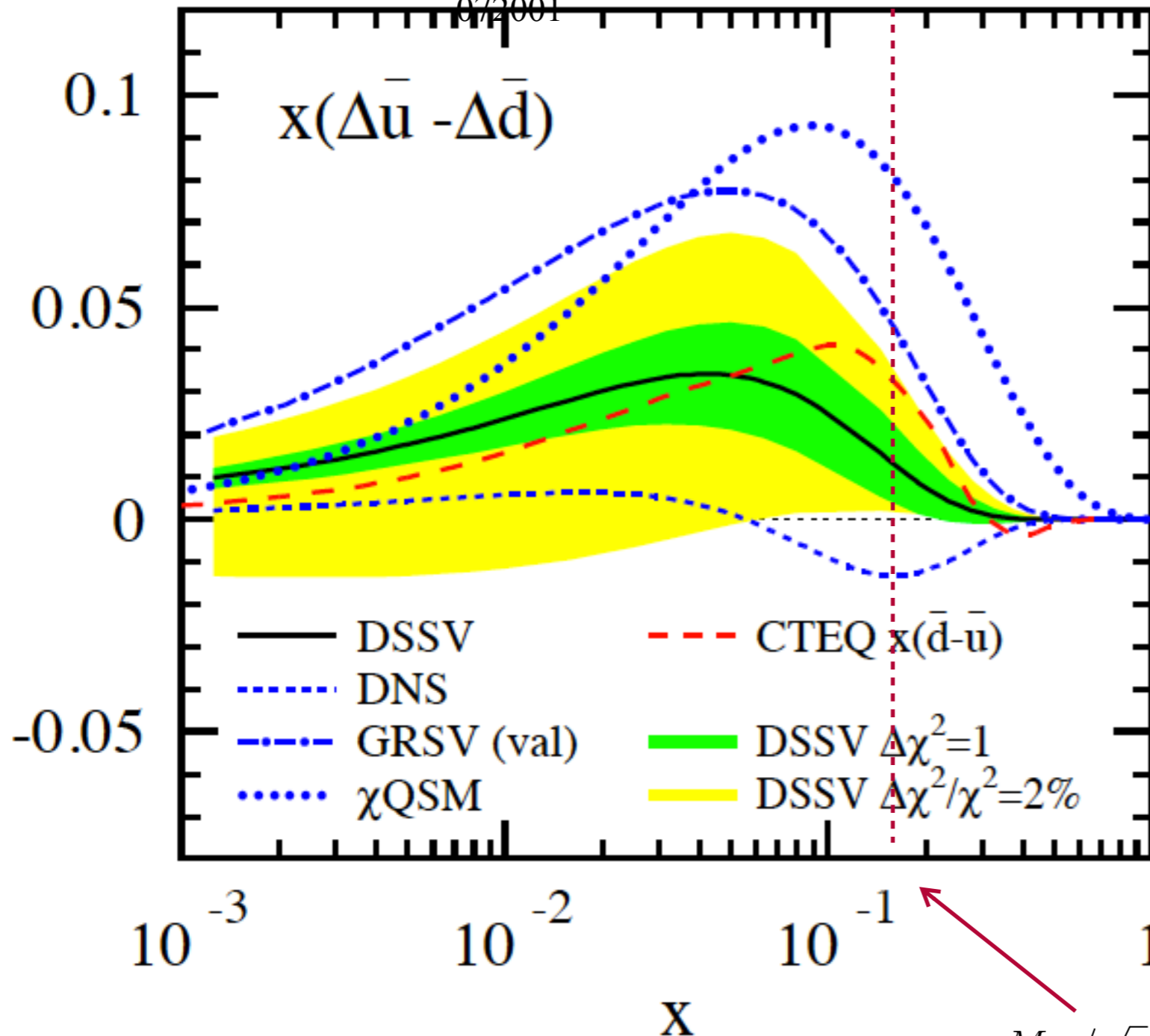

○ From recent DSSV
++ result incl.

STAR A_L data:

$$\int_{0.05}^1 \Delta\bar{u}(x, Q^2) dx \approx 0.02$$

$$\int_{0.05}^1 \Delta\bar{d}(x, Q^2) dx \approx -0.05$$

$$M_W/\sqrt{s} = 0.16$$

Mid-Rapidity charge sign separation

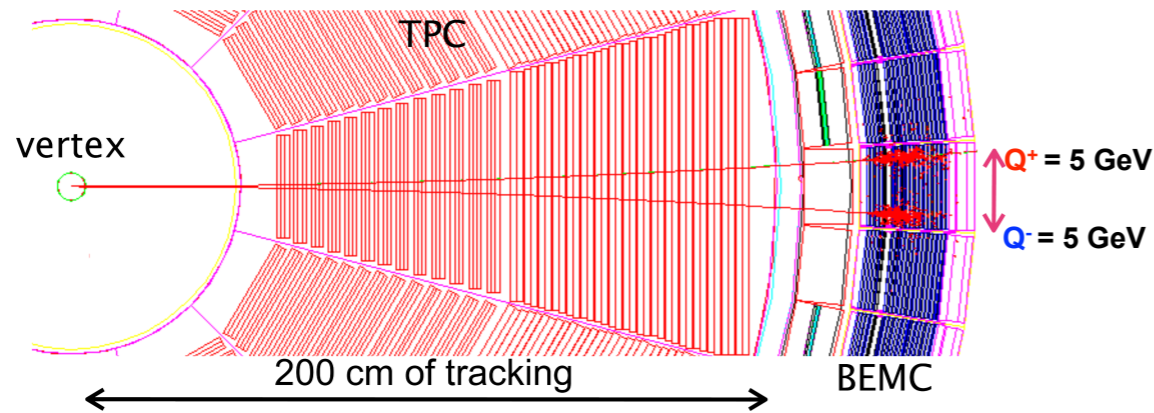

- Charge sign reconstruction based on TPC track bending
- Estimate wrong sign contamination by fitting $Q * E_T/p_T$ with Gaussian.

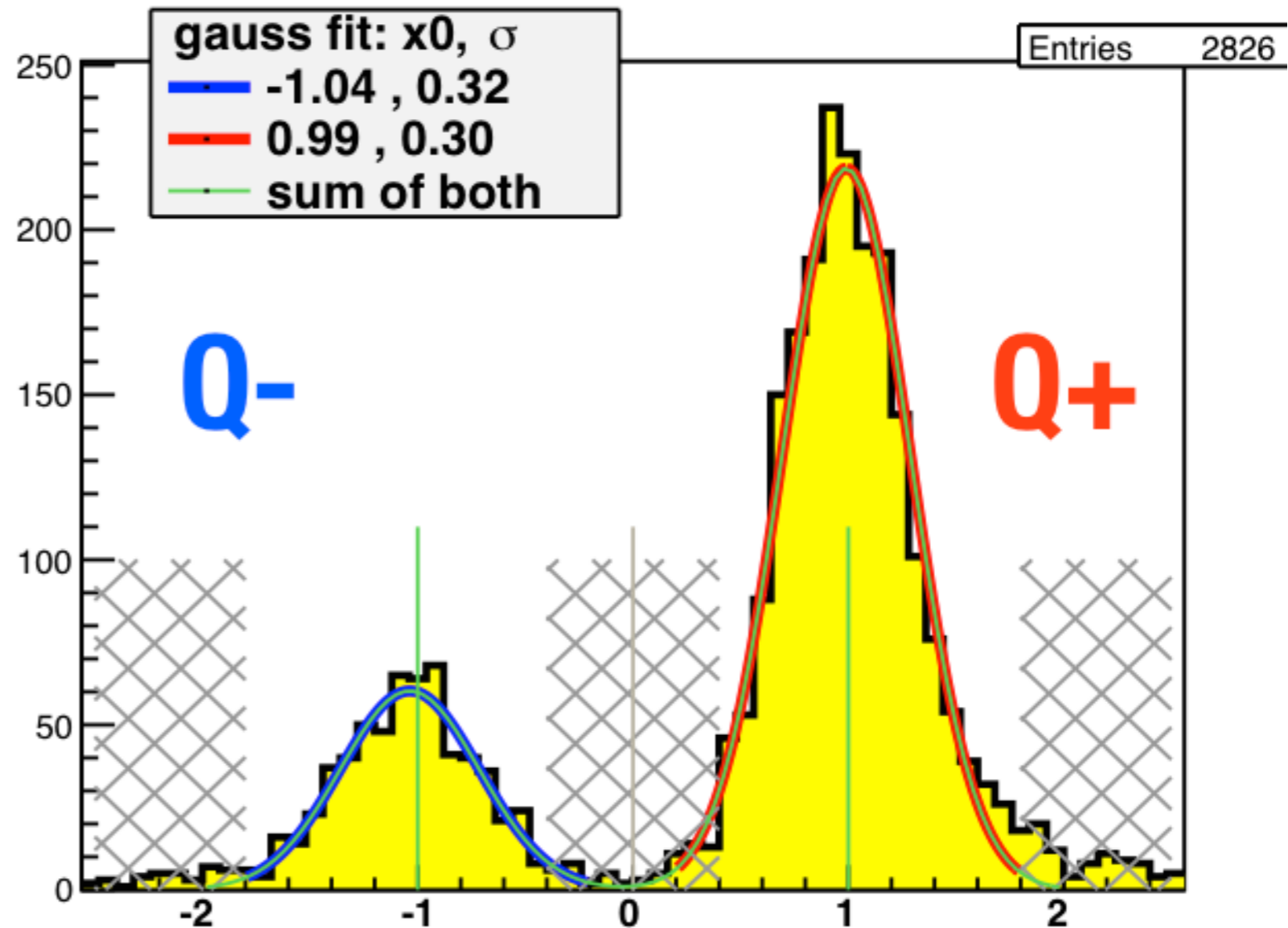

Extracting Asymmetries using Profile Likelihood Method

- Profile Likelihood method used in extracting Asymmetries from combination of run 2012 and run 2011 data [simple gaussian uncertainties breakdown particularly for small 2011 data sample]
- Define likelihood function for 8 spin-dependent yields from pair of symmetric η region of STAR

$$L = \prod_i^4 p(M_i^a | \mu_i^a) p(M_i^b | \mu_i^b) g(\beta^a) g(\beta^b)$$

$p(M_i | \mu_i)$ - Poisson probability, for measured spin sorted yield M_i in the expected value μ_i given by:

$$\mu_{++}^a = I_{++} N (1 + P_1 \beta A_L^{+\eta_e} + P_2 \beta A_L^{-\eta_e} + P_1 P_2 \beta A_{LL})$$

$$\mu_{+-}^a = I_{+-} N (1 + P_1 \beta A_L^{+\eta_e} - P_2 \beta A_L^{-\eta_e} - P_1 P_2 \beta A_{LL})$$

$$\mu_{-+}^a = I_{-+} N (1 - P_1 \beta A_L^{+\eta_e} + P_2 \beta A_L^{-\eta_e} - P_1 P_2 \beta A_{LL})$$

$$\mu_{--}^a = I_{--} N (1 - P_1 \beta A_L^{+\eta_e} - P_2 \beta A_L^{-\eta_e} + P_1 P_2 \beta A_{LL})$$

P_1, P_2 - beam polarization $A_L^{+\eta_e} (A_L^{-\eta_e})$ - single spin asymmetry
 A_{LL} - double spin asymmetry N - spin averaged yield $I_{\pm\pm}$ - relative luminosity

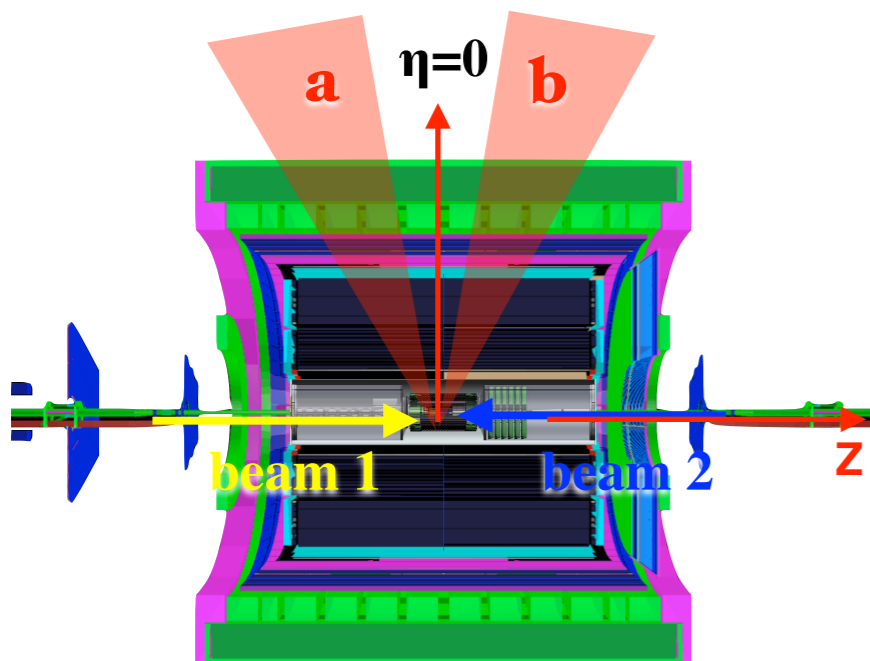

$g(\beta)$ - Gaussian probability for estimated dilution background β

Extract asymmetries from likelihood function $L_{2011} \times L_{2012}$

Run 12 Preliminary results compare to Final

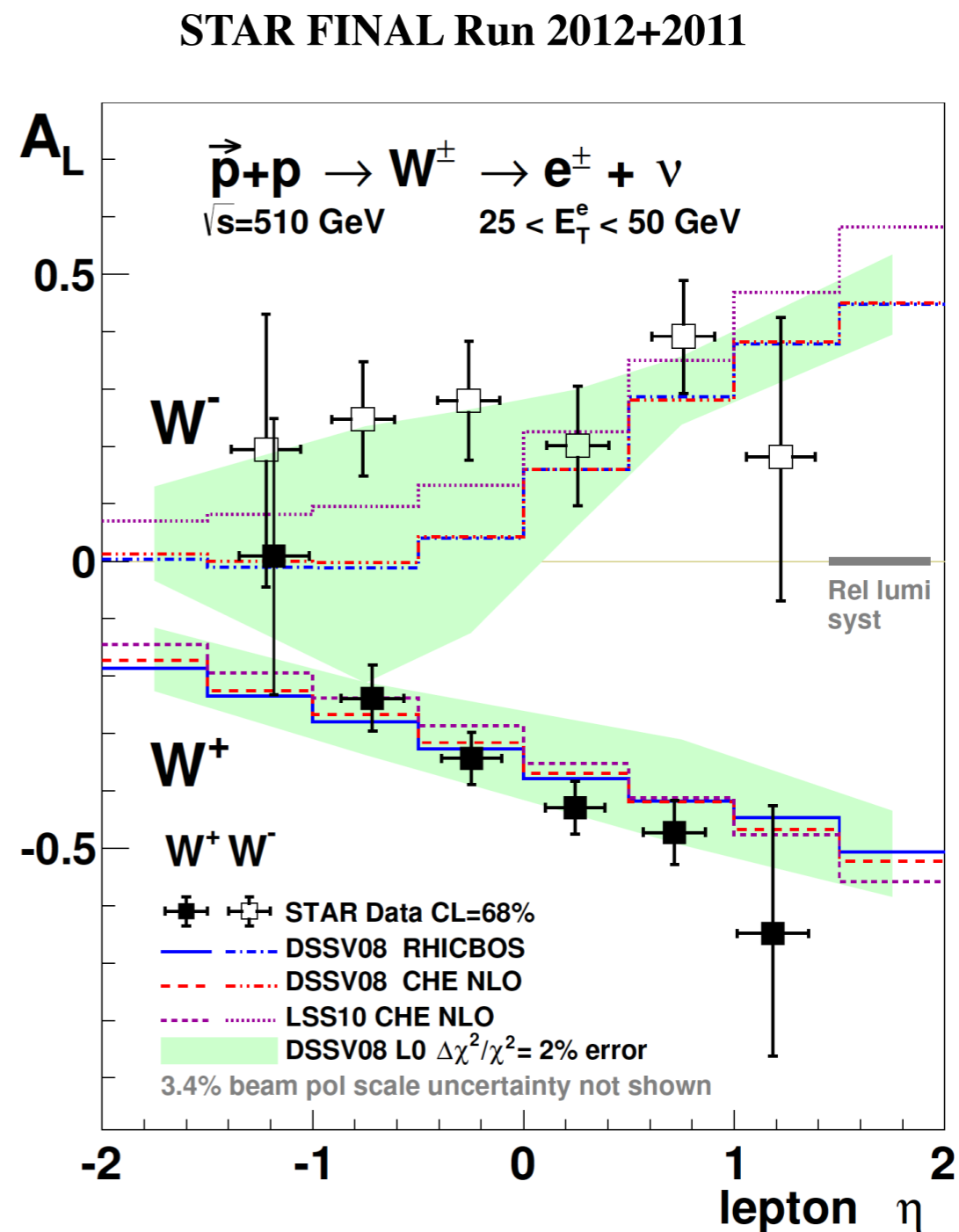
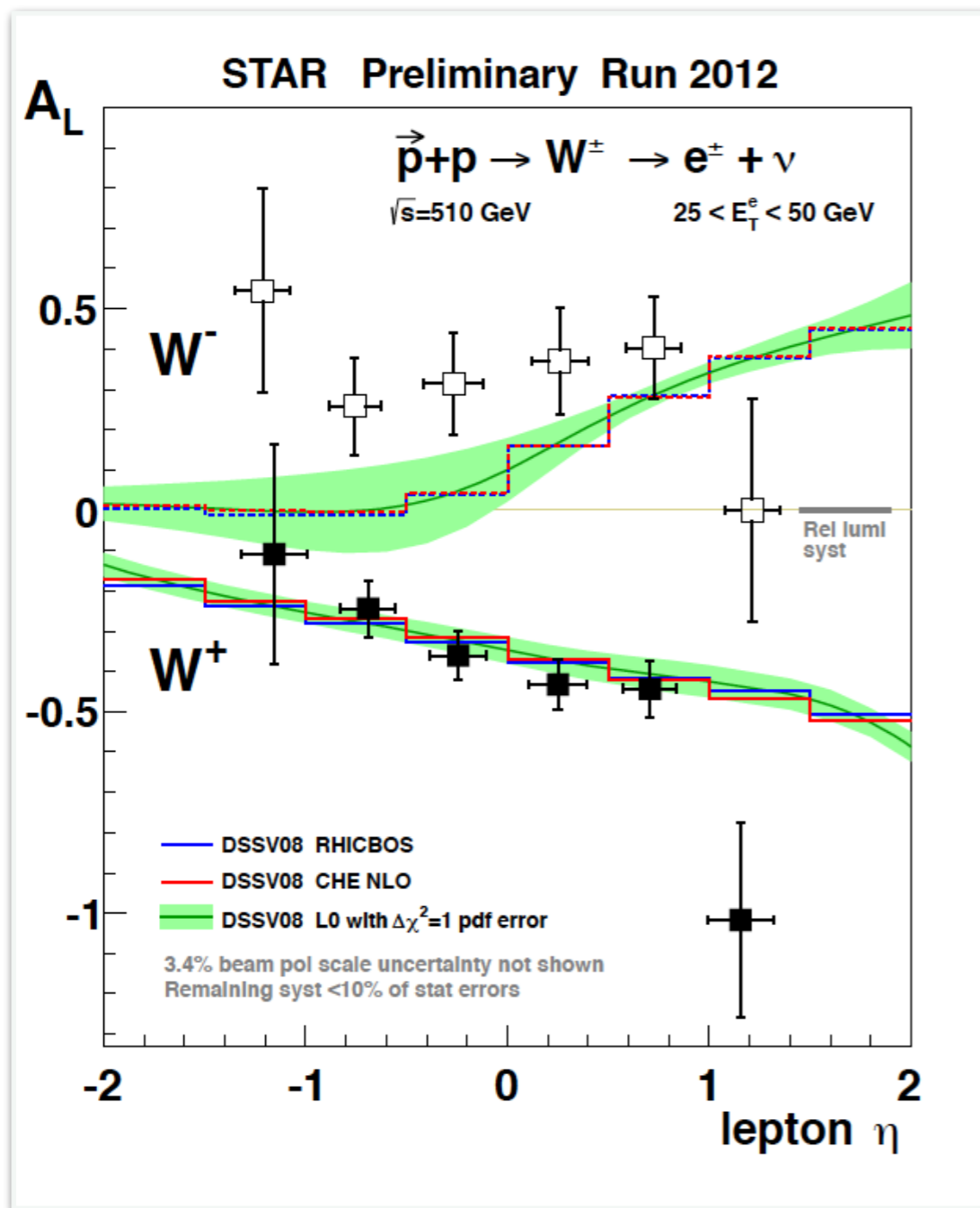

PRL 113,72301 (2014)

Endcap W Selection

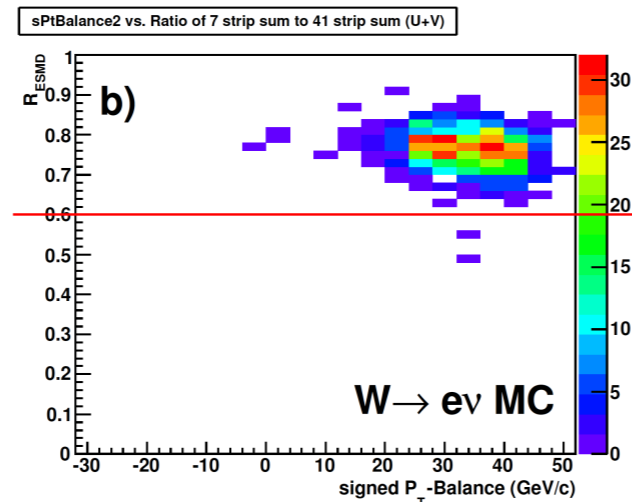
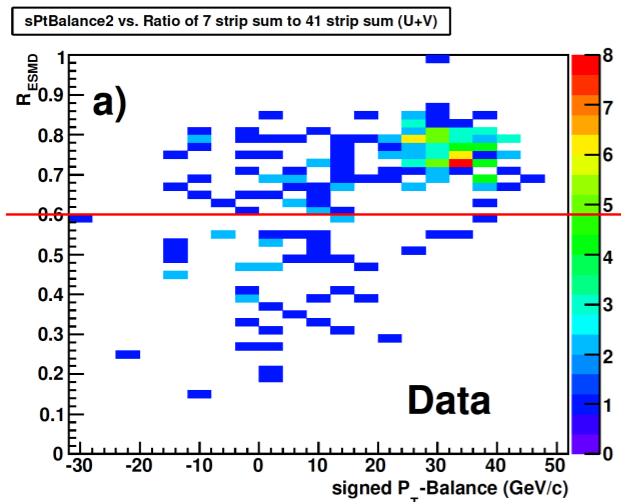
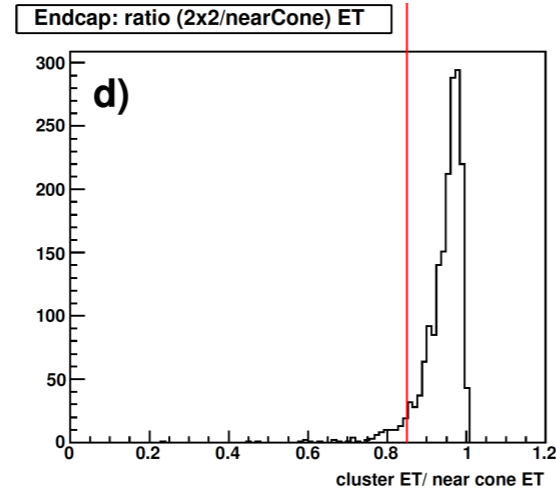
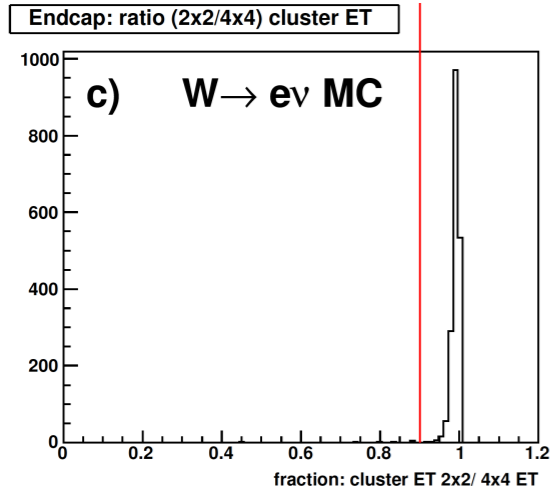
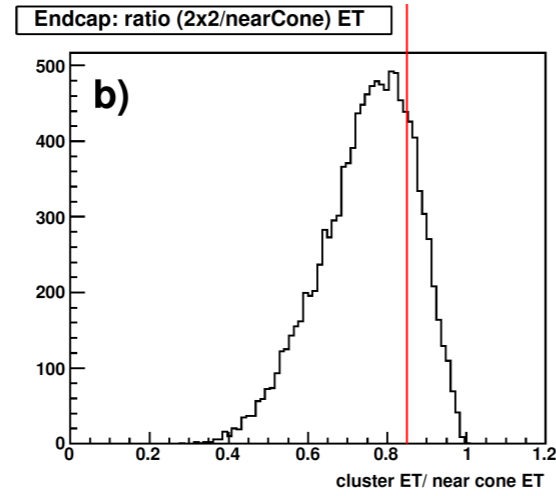
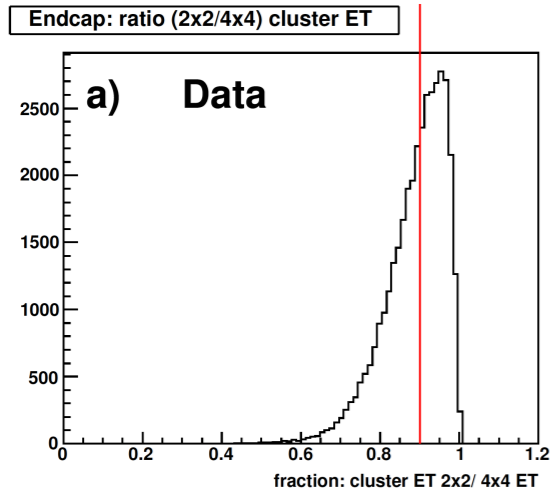

ESMD CUTS

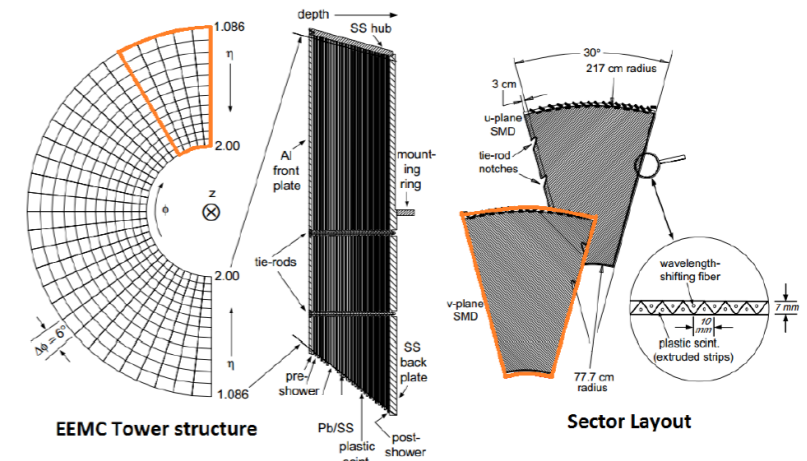
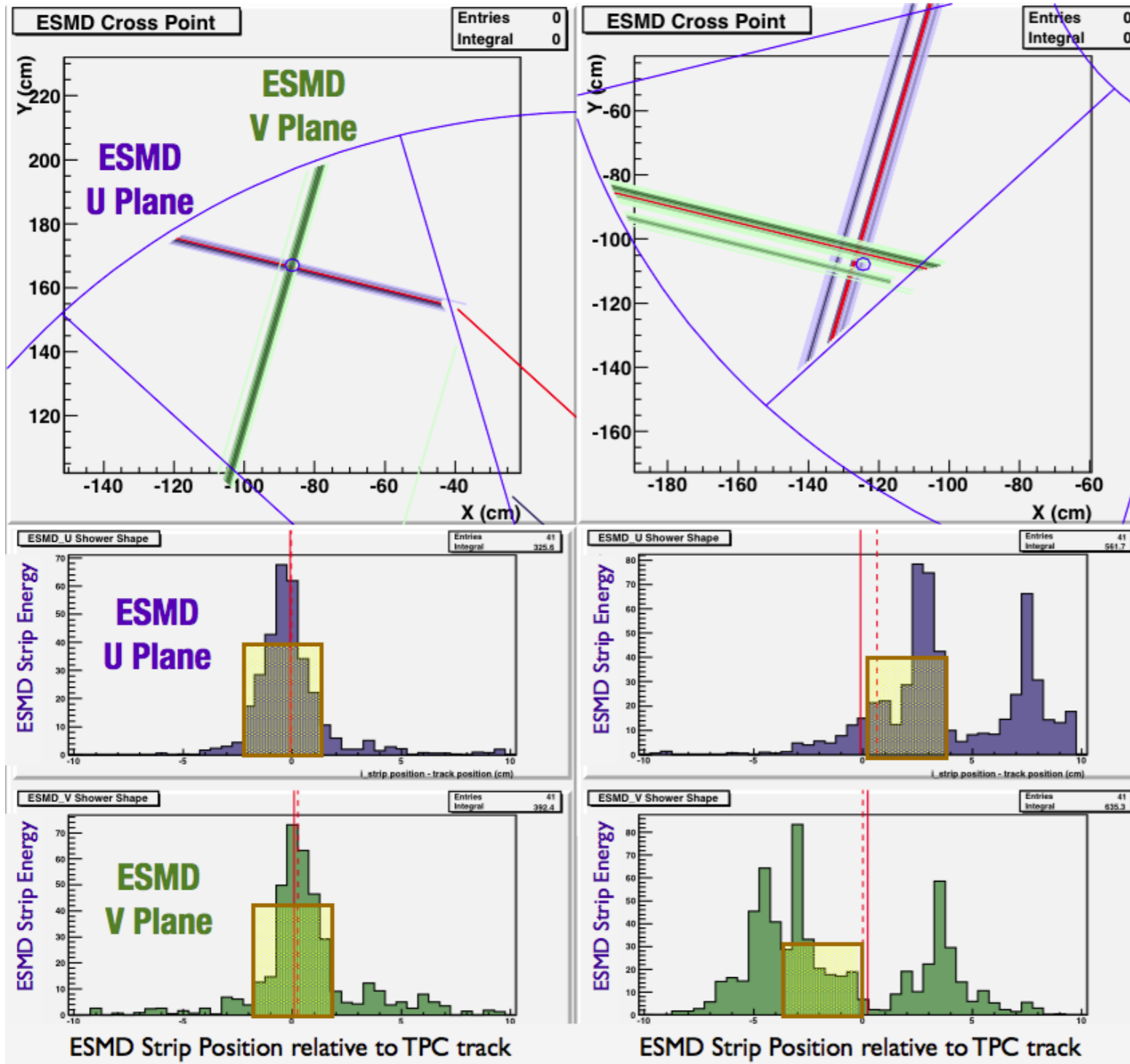

$$R_{ESMD} = \frac{\sum_{i=-3}^{+3} E_i^U + E_i^V}{\sum_{i=-20}^{+20} E_i^U + E_i^V}$$

Forward Rapidity Background Estimation and charge sign separation

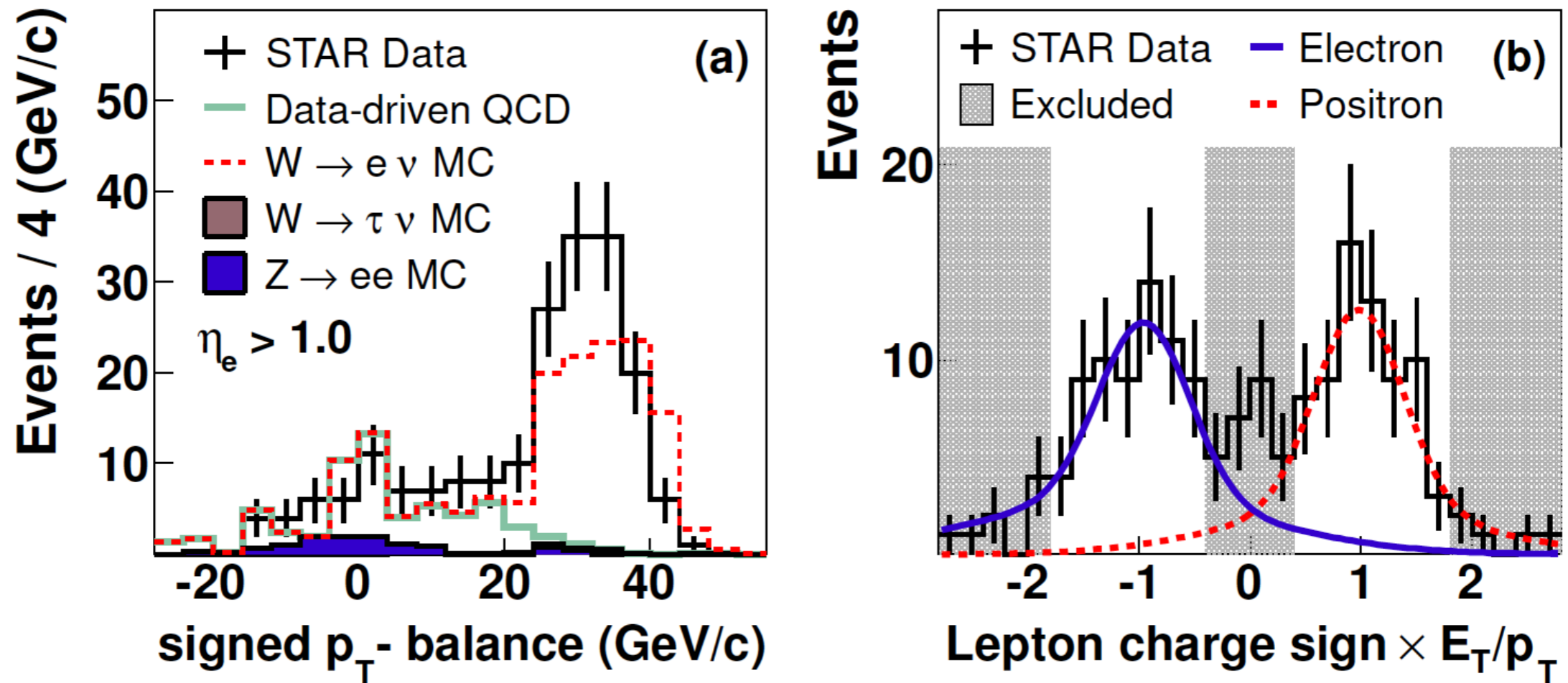

PRL 113,72301 (2014)

Run 12 ALL and Z AL results

$$A_{LL} = \frac{(\sigma^{++} + \sigma^{--}) - (\sigma^{+-} + \sigma^{-+})}{(\sigma^{++} + \sigma^{--}) + (\sigma^{+-} + \sigma^{-+})}$$

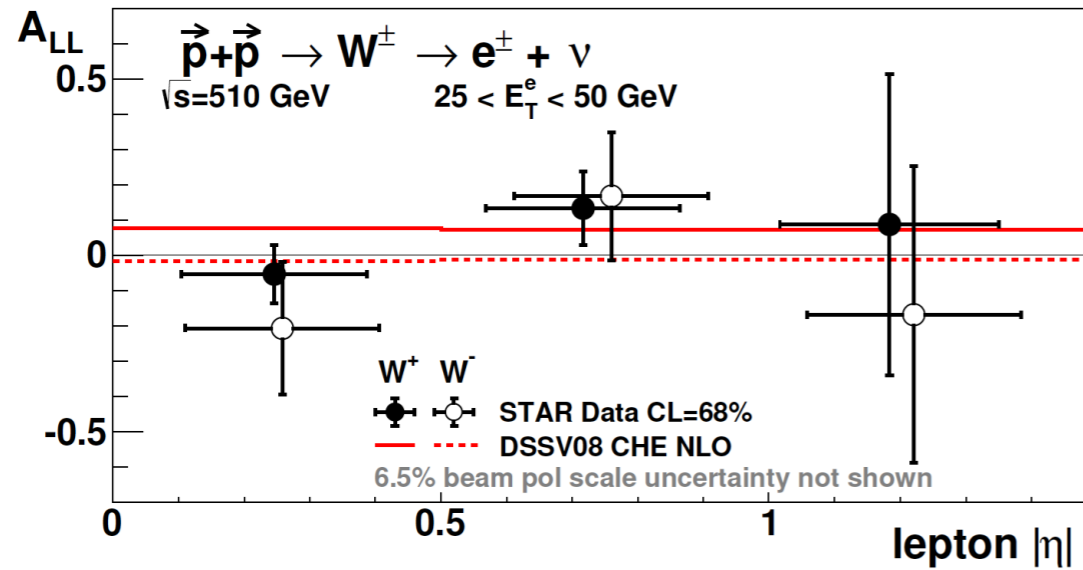

PRL 113,72301 (2014)

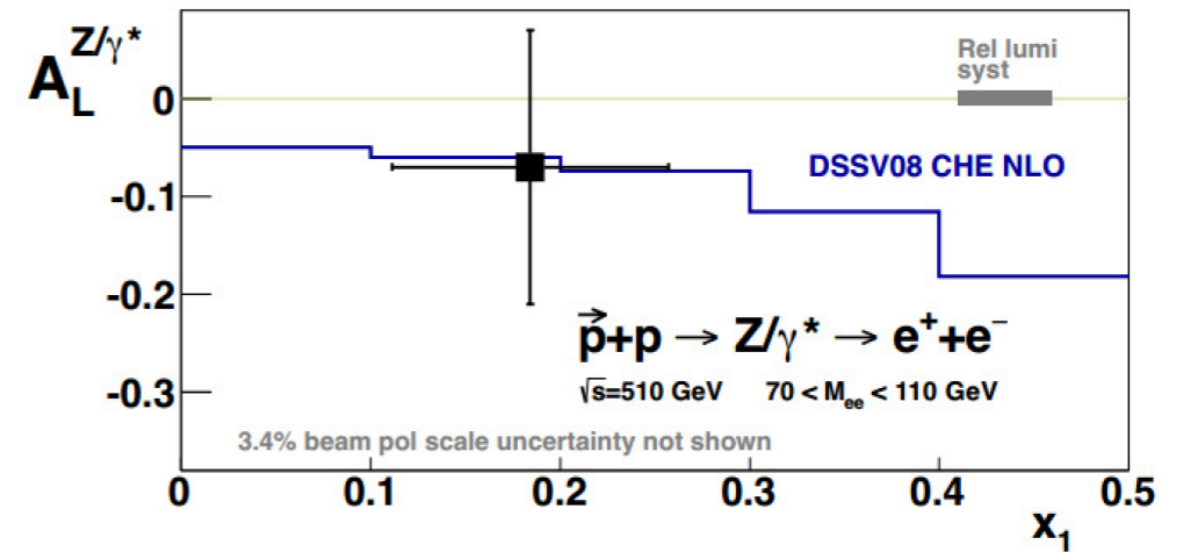

Z invariant mass

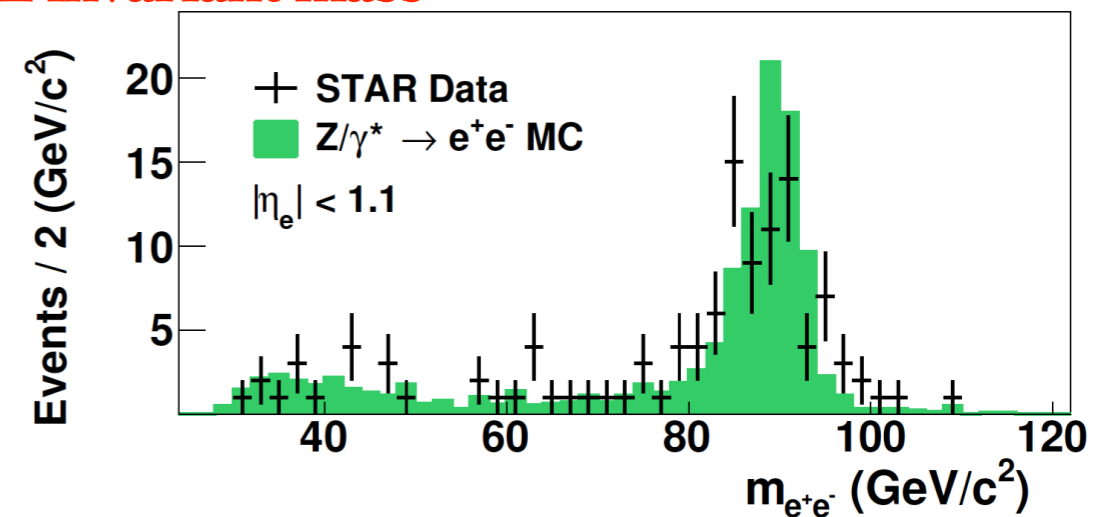

PRL 113,72301 (2014)

- Probes different combination of quark polarizations

$$A_{LL} = \frac{\sigma^{++} - \sigma^{+-}}{\sigma^{++} + \sigma^{+-}} \quad A_{LL}^{W^+} \sim \frac{\Delta u}{u} \frac{\Delta \bar{d}}{\bar{d}} \quad A_{LL}^{W^-} \sim \frac{\Delta d}{d} \frac{\Delta \bar{u}}{\bar{u}}$$

- Asymmetries expected to be smaller, and first measurement consistent with predictions from DSSV

W production: more details

Helicity structure can see in the differential cross section of W

$$\frac{d\sigma_{W^+}}{d\cos\theta} \propto \bar{d}(x_1)u(x_2)(1 + \cos\theta)^2 + u(x_1)\bar{d}(x_2)(1 - \cos\theta)^2$$

$$\frac{d\sigma_{W^-}}{d\cos\theta} \propto \bar{u}(x_1)d(x_2)(1 - \cos\theta)^2 + d(x_1)\bar{u}(x_2)(1 + \cos\theta)^2,$$

W tends to boost direction of the valance quark traveling

Helicity structure of the interaction causes lepton to emit parallel (antiparallel) to W-(W+)



higher (lower) x parton in the collision is most likely quark (antiquark) . And quark is very likely to come from valance region

W longitudinal momentum

e decay kinametics in lab frame related to W boost direction

$$p_{L,W} = \frac{\sqrt{s}}{2} (x_1 - x_2)$$

$$p_{L,e}^{lab} = \frac{1}{\gamma} p_{L,e}^* + \beta E_e^{lab}, \quad p_{L,e}^* = \cos\theta \cdot M_W/2 \quad (p_T^e = \sin\theta \cdot M_W/2),$$

W, di-Jet and Z type events

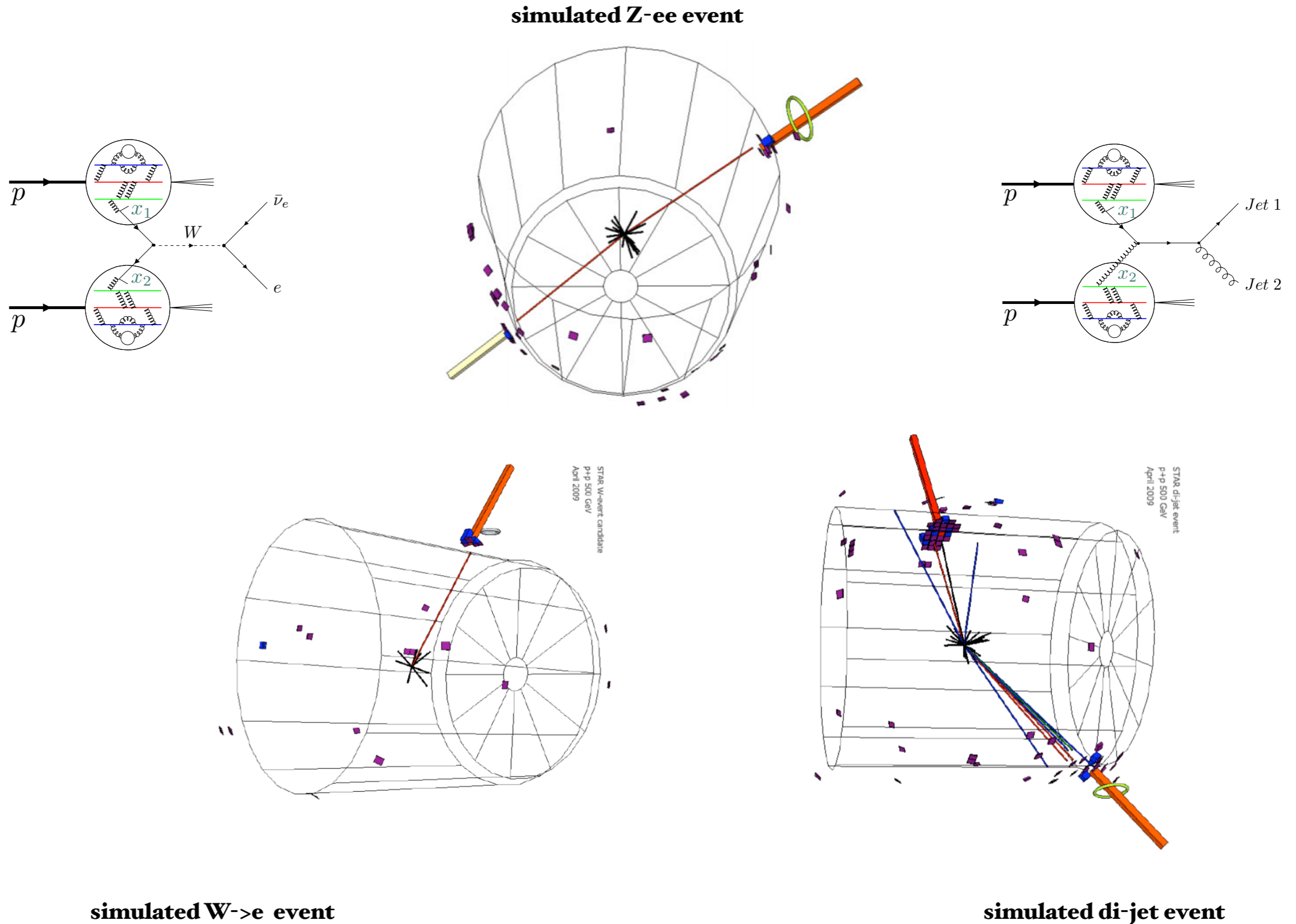

Mid-rapidity ($|\eta_e| < 1$) W Selection

❖ Match $P_T > 10$ GeV TPC tracks to EMC cluster

$$E_T^e / E_T^{4 \times 4} > 0.95$$

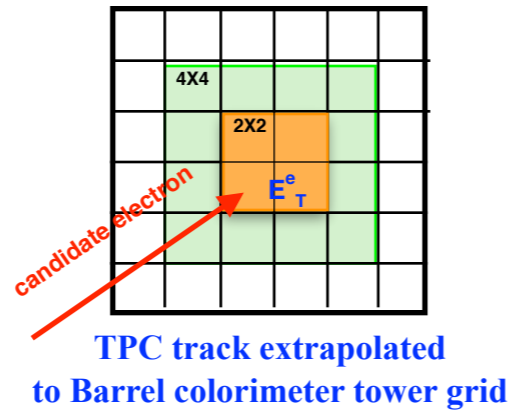

❖ Isolate from QCD di-jet type event

$$E_T^e / E_T^{\Delta R < 0.7} > 0.88$$

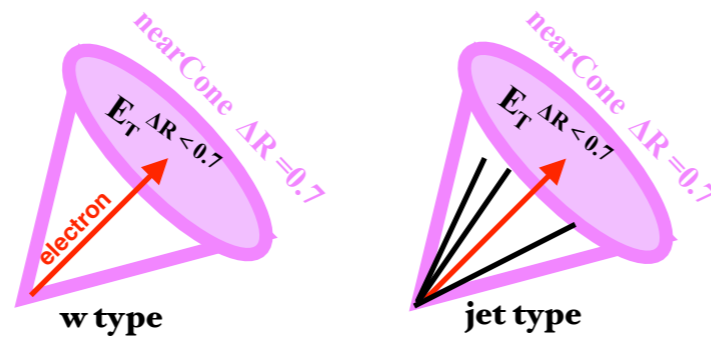

❖ Use Larger imbalance of transverse momentum

$$\vec{P}_T^{balance} = \vec{P}_T^e + \sum_{\Delta R > 0.7} \vec{P}_T^{jets}$$

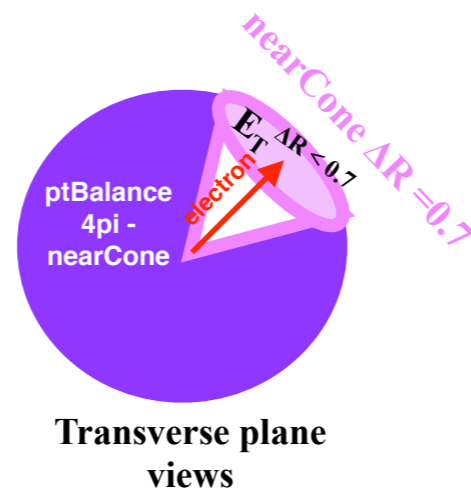

❖ e^+ and e^- Charge sign Separation

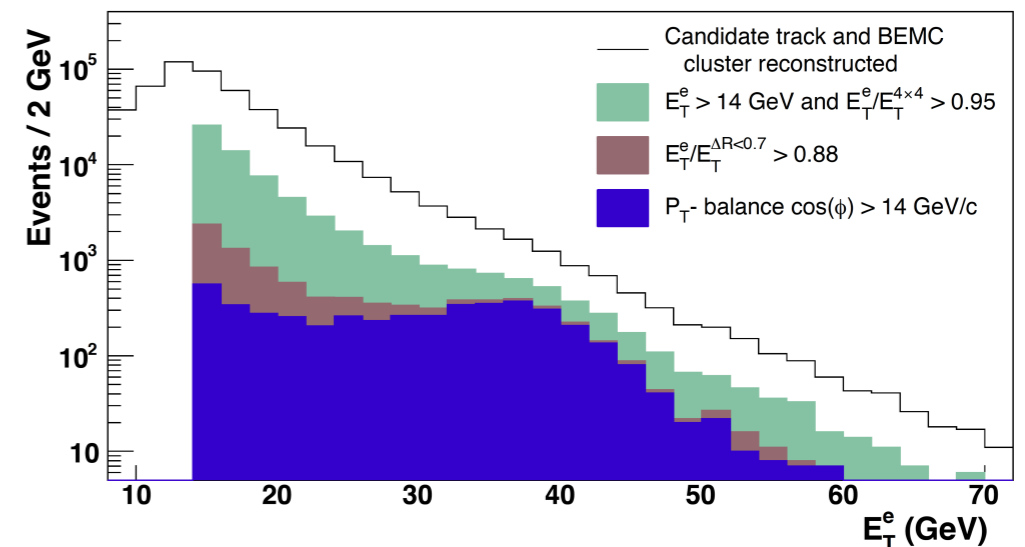
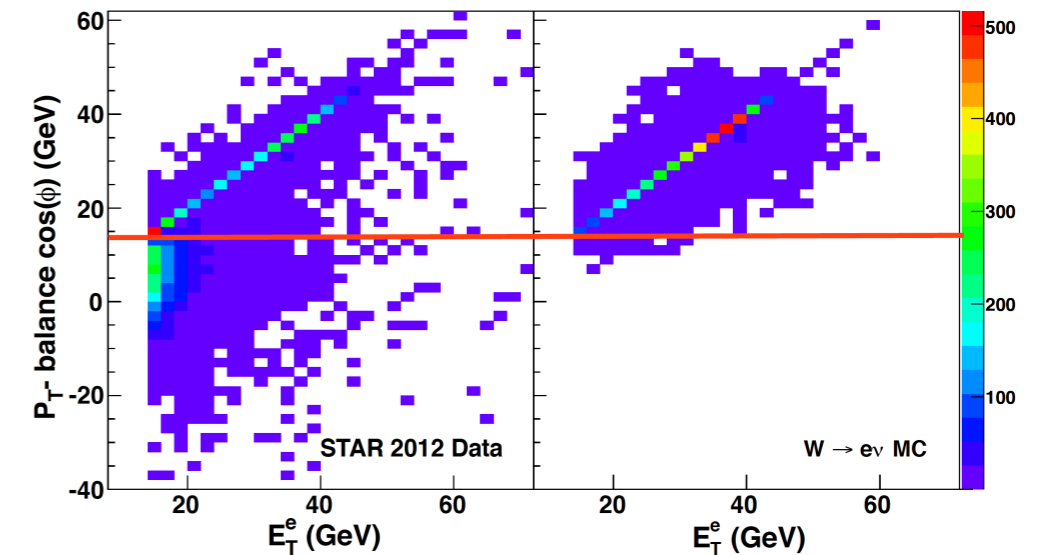
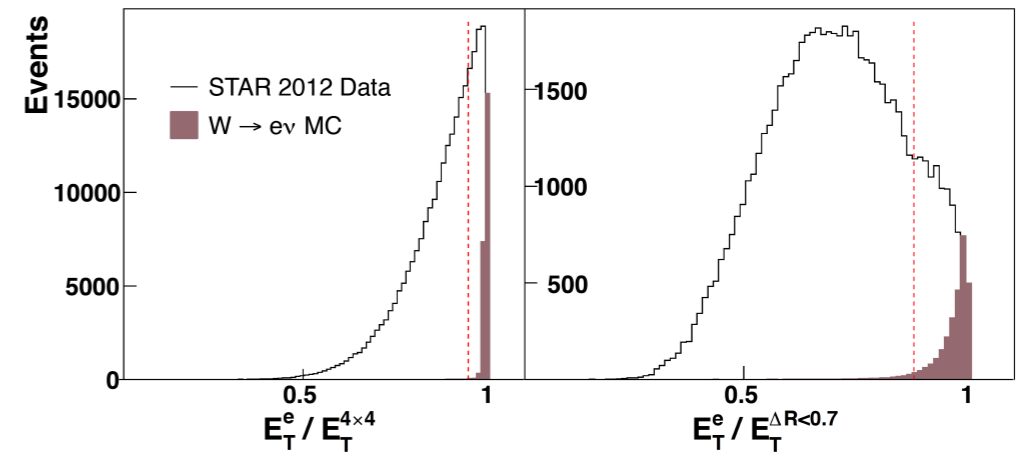

FGT

Illustration of charge-sign discrimination

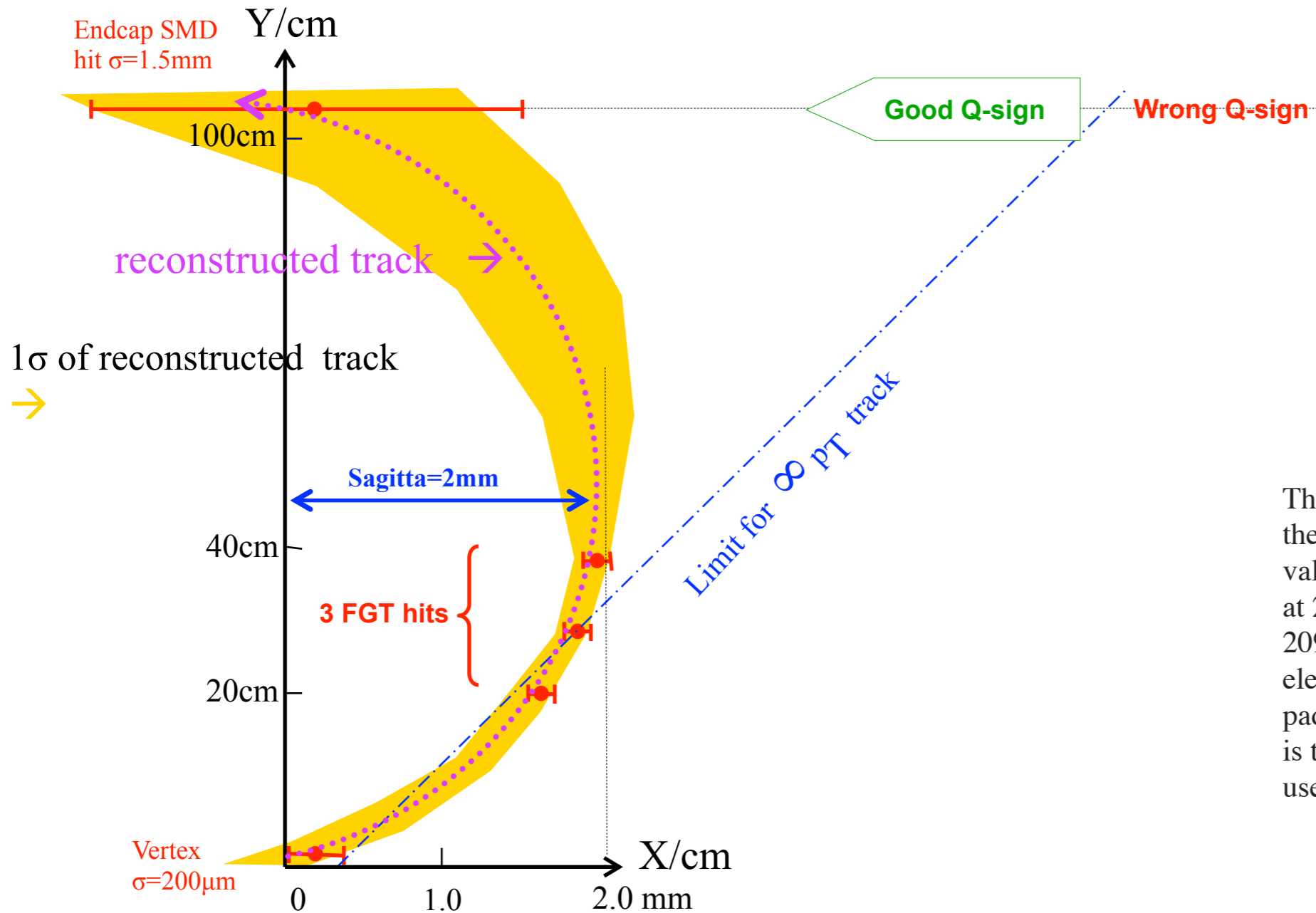

The TPC prompt hits are 'hits' using the ANODE wires located at large Z values at 209.5 cm for inner subsectors and 209.7 cm for outer subsectors. The electrons from a charge drift to the pad planes. The 'first signal in time' is then used to define a prompt hit.

FGT track reconstruction

- Comparison of data / fast MC: Track reconstruction

R ISOLUTION

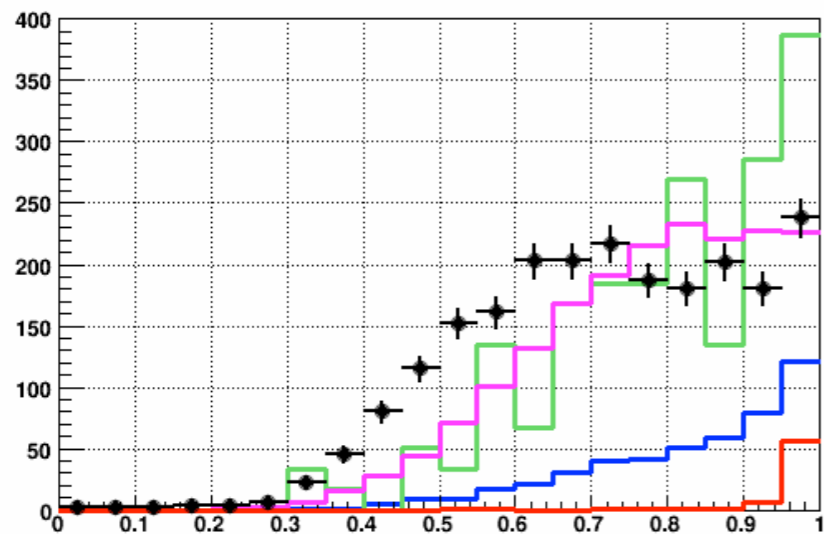

p_T [GeV/c]

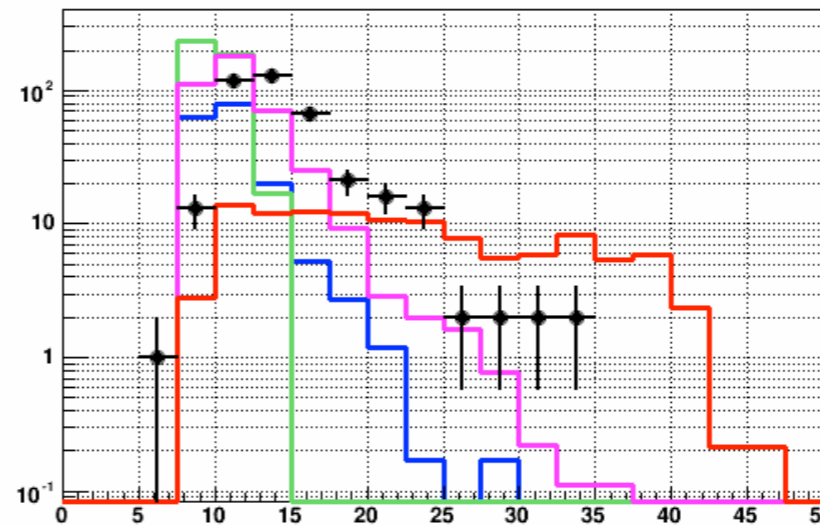

Run13 Data (FGT+VTX
+EEMC, no prompt)

PYTHIA QCD charged
hadrons

E [GeV]

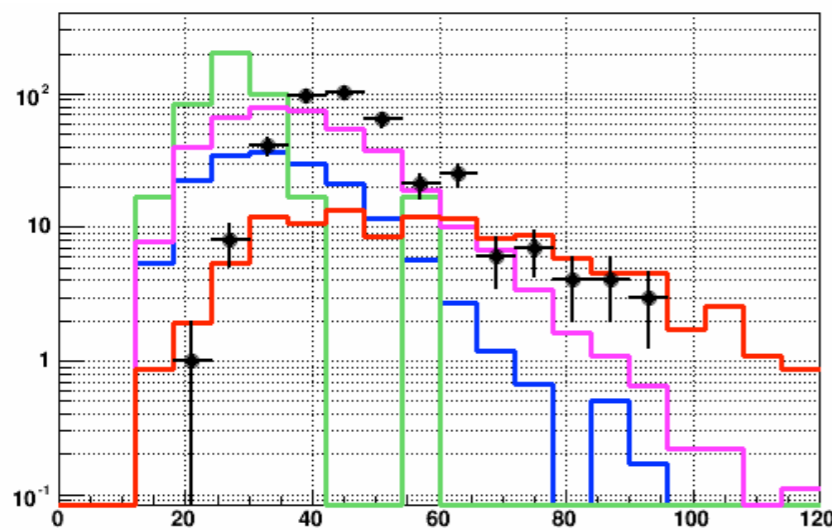

PseudoRapidity

50GeV/c

PYTHIA W

PYTHIA QCD electrons

PYTHIA QCD photons

100GeV

0

3

The central values are both from the theoretical predictions. So the central values of the polarized anti-u and anti-d quarks should be same. The the uncertainties are estimated from the W yields. For the old version, it maybe estimated from the run9 W efficiency. But for the new version, the W yields are estimated from run13 W efficiency. Due to the higher $\langle z_{dc} \rangle$ rate , the later one should be a little smaller. I roughly compared the error bars in these two projection plots, the differences is very slight, something like $<10\%$. But, for the new version, we indeed don't have the corresponding polarized anti-u and anti-d distribution.

[simple gaussian uncertainties breakdown particularly for small 2011 data sample]

