

Central Exclusive Production in Proton-Proton Collisions with the STAR Experiment at RHIC

Włodek Guryn
For the STAR Collaboration

1. Physics motivation: Central Exclusive Production in Double Pomeron Exchange process;
2. Experimental Setup: RHIC complex, STAR detector, Roman Pots.
3. Data sample
4. Preliminary Results:
 - Results on exclusive $\pi^+\pi^-$ production from Roman Pot Phase I
 - Mass spectrum of exclusive $\pi^+\pi^-$ production from Run 2015
 - Mass spectrum of exclusive K^+K^- production from Run 2015
5. Summary and outlook.



Central Production at High Energies

As predicted by Regge theory the diffractive cross section at high energy, including RHIC is dominated by the Pomeron (gluonic) exchange:

$$\sigma_{RR} \sim s^{-2}$$

$$\sigma_{RP} \sim s^{-1}$$

$$\sigma_{PP} \sim \text{const. or } s^\alpha \text{ where } \alpha \sim (0.1)$$

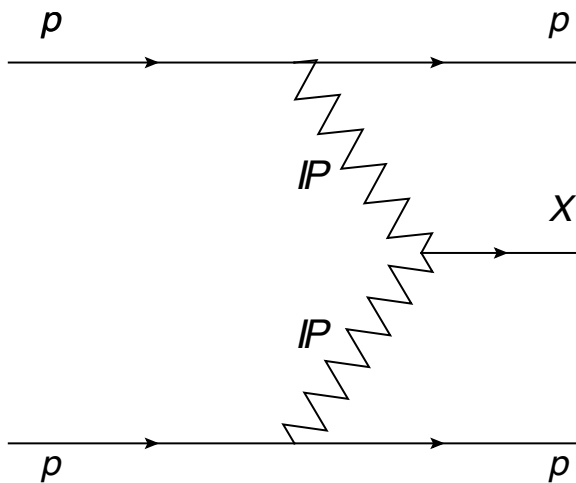

Regge Theory

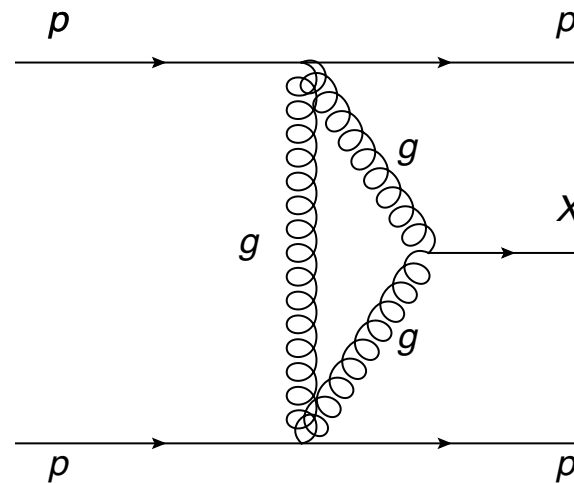

pQCD

Central Production at High Energies

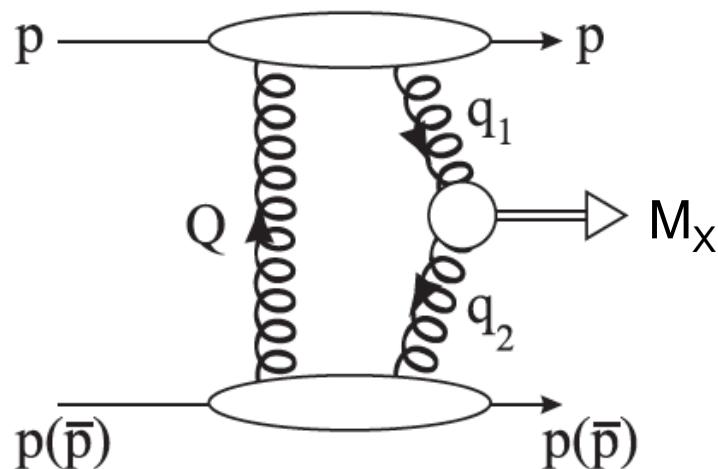

- Colliding protons interact via a colour singlet exchange and remain intact after the interaction.
- In the collider experiment those protons follow magnetic field of the accelerator and remain in the beam pipe.
- A system of mass M_x is produced, whose decay products are present in the central detector region.
- Tagging on forward protons assures rapidity gap (modulo) soft rescattering processes, which fill the gap. Such effect is quantified by gap survival probability factor.

Central Exclusive Production in DPE

In the Central Exclusive Production process there is a **momentum balance between the central system M_x and the outgoing protons.**

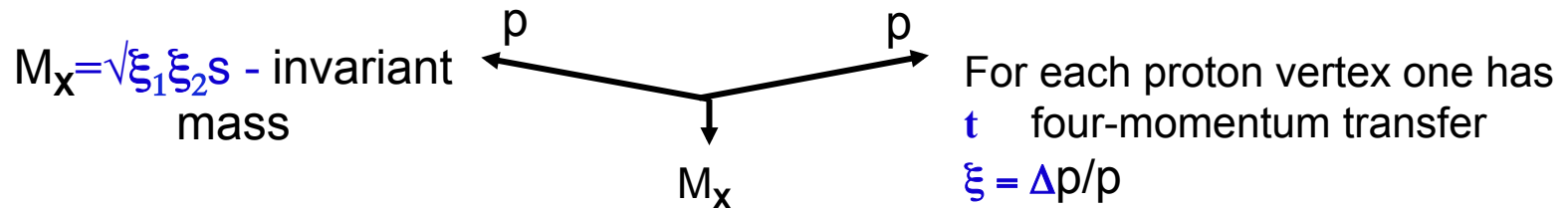

The massive system could form resonances. We expect that **because of the constraints provided by the double Pomeron interaction, glueballs, hybrids, and other states coupling preferentially to gluons,** will be produced with much reduced backgrounds compared to standard hadronic production processes.

Glueball Spectrum

Sparse spectrum!

New $I=0$ mesons starting with

0^{++} **1.6 GeV**

0^{-+} , 2^{++} **2.3 - 2.5 GeV**

No **J^{PC} -exotic** glueballs until

2^{+-} at 4 GeV

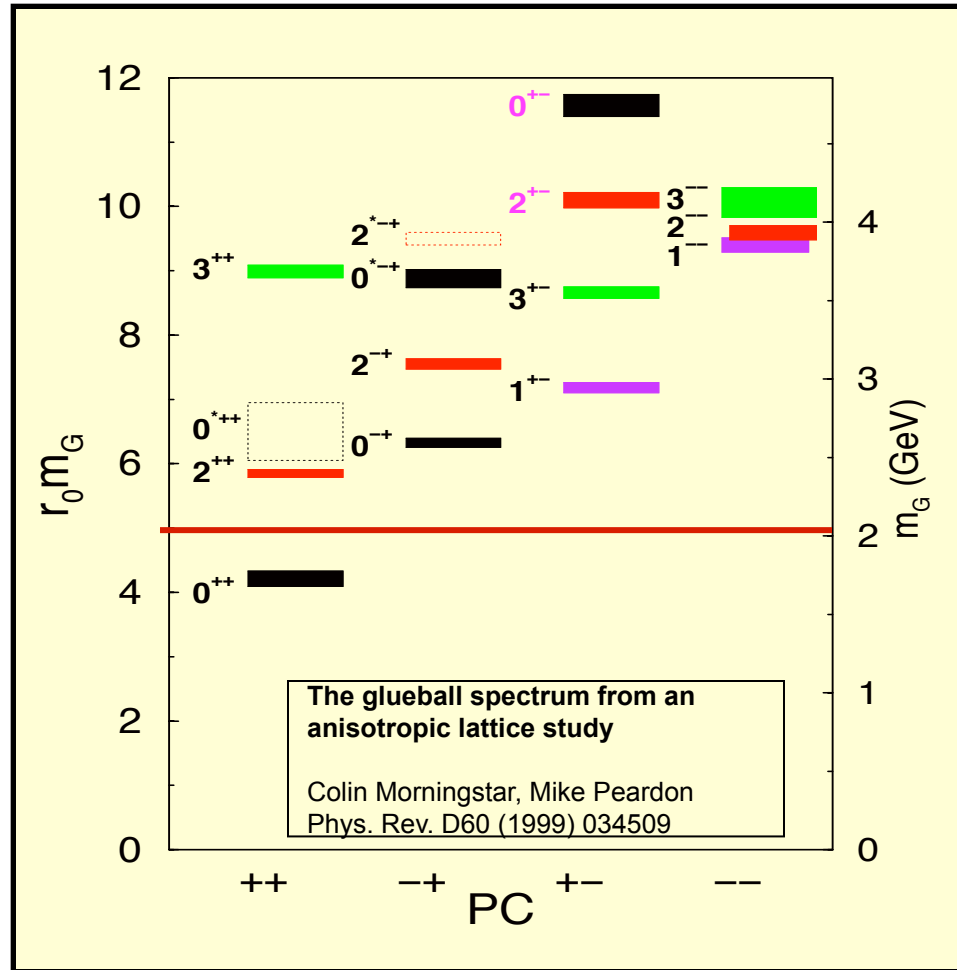

The Relativistic Heavy Ion Collider

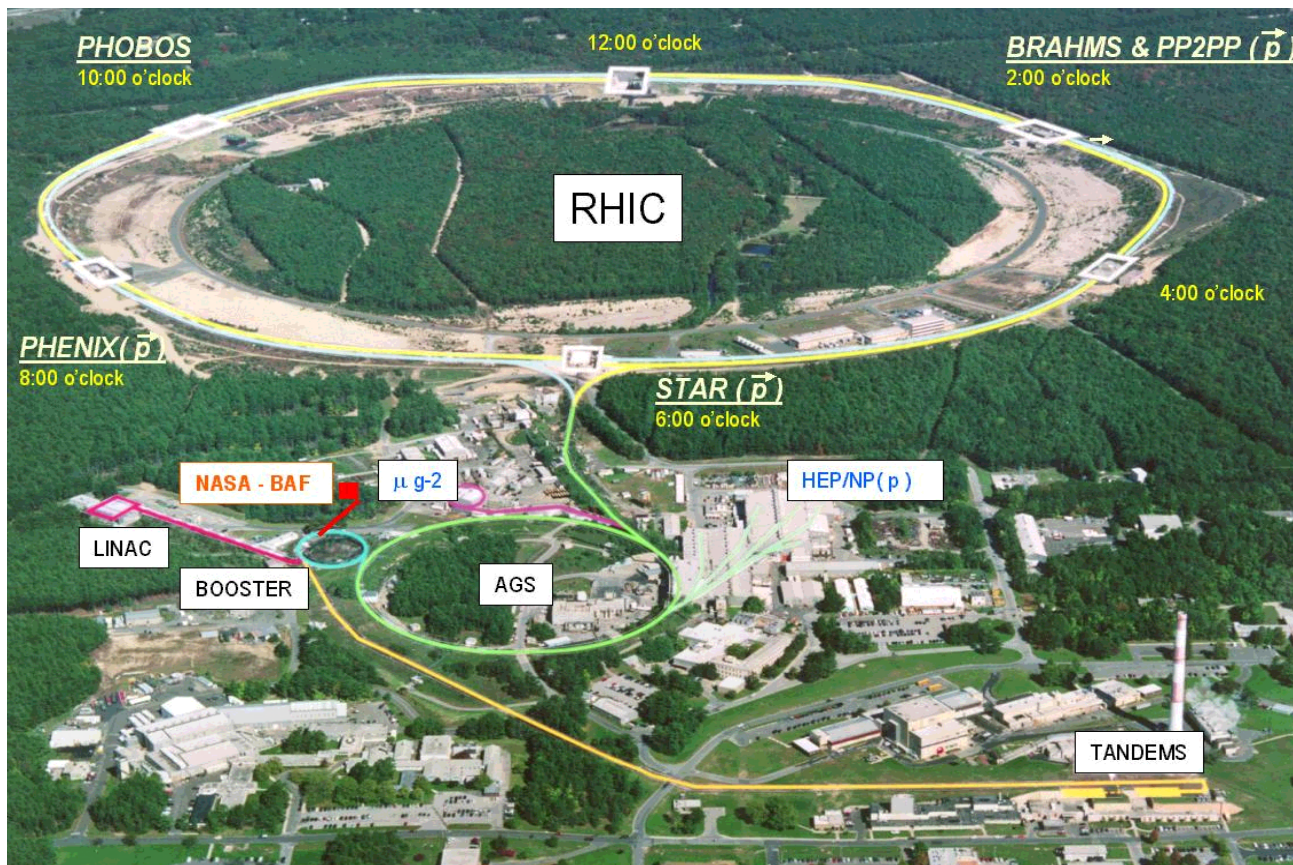

RHIC is a QCD Laboratory:

Nucleus- Nucleus collisions (AuAu, CuCu...); Asym. Nucl. (dAu, pAu, HeAu); Polarized proton-proton; eRHIC - Future

How to measure – Implementation at STAR

1. Need detectors to measure forward protons: t - four-momentum transfer squared and $\xi = \Delta p/p$, M_x invariant mass **Roman Pots of PP2PP** and;
2. Detector with good acceptance and particle ID to measure central system - **STAR**

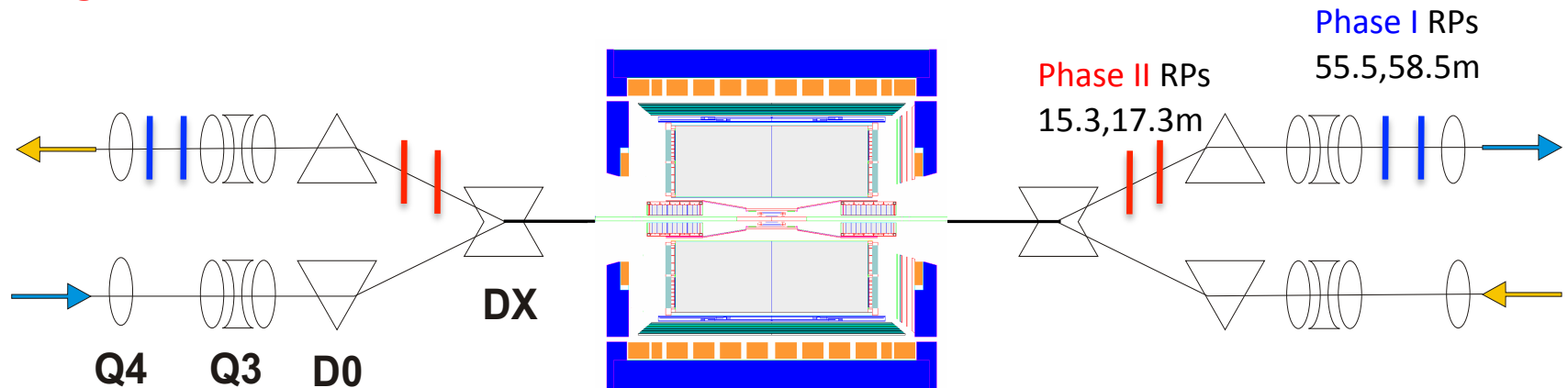

1. Roman Pots (RP) detectors to measure forward protons
2. Staged implementation for wide kinematic coverage
 - Phase I, low- t coverage run 2009
 - Phase II*, current, no special conditions required Run 15 and Run 17
 - Phase II with bigger acceptance, new detectors will be needed.

Implementation at RHIC – Tag Forward Protons

Setup of the PP2PP experiment, used to measure pp elastic scattering at RHIC was moved to STAR to advance a physics program with tagged forward protons

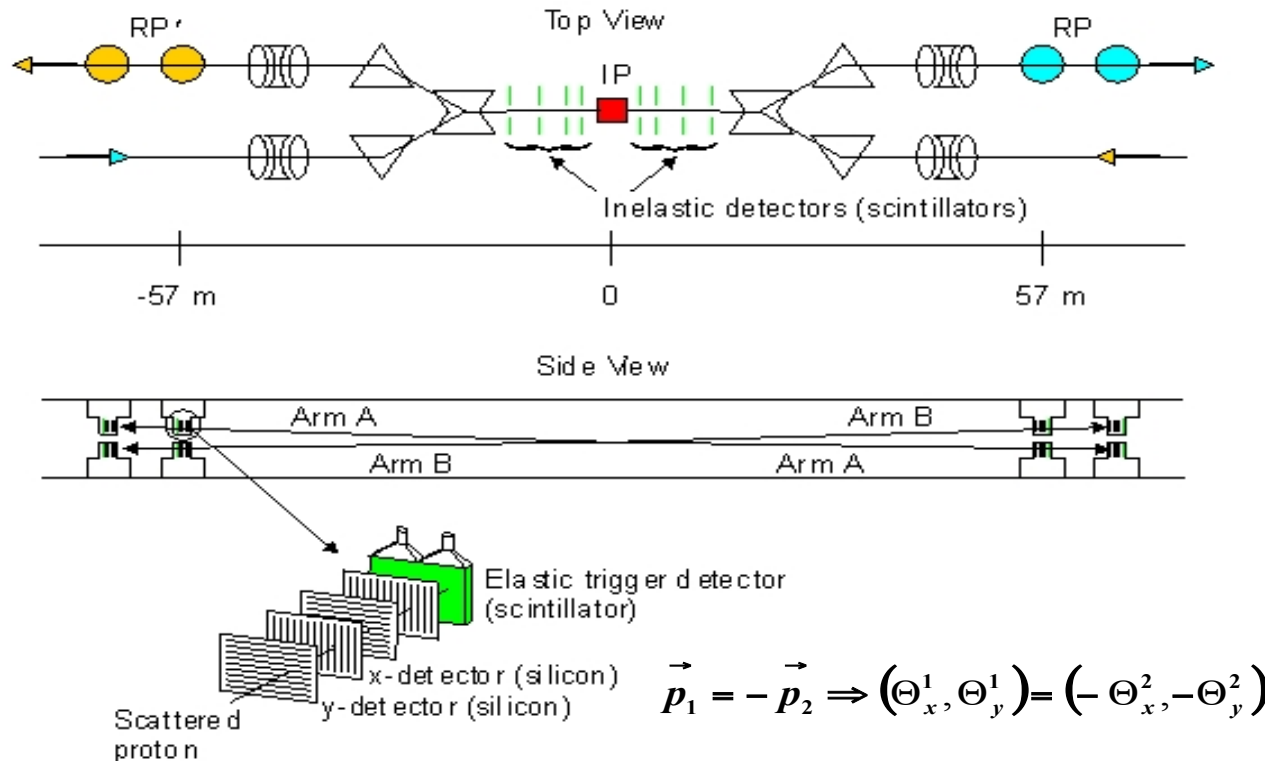

The PP2PP Setup



Roman Pot Station PP2PP and 2009

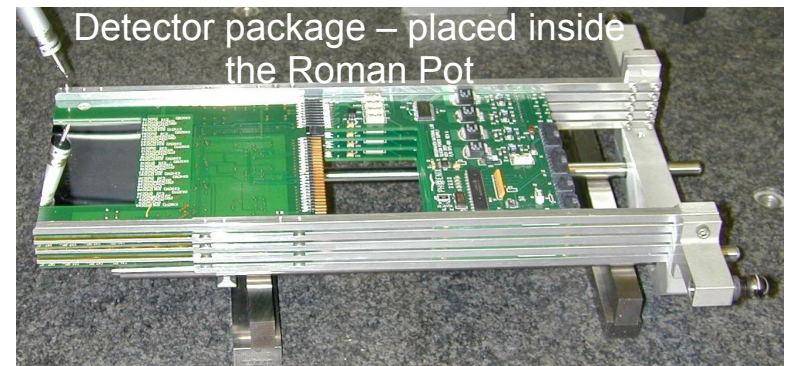

Phase I preliminary results

Kinematic coverage:

$$0.005 < -t < 0.03 \text{ GeV}^2/c^2$$

$$0 < \phi < 2\pi \quad |\eta_\pi| < 1 \quad |\eta_{\pi\pi}| < 2$$

Detector layout description: [9]

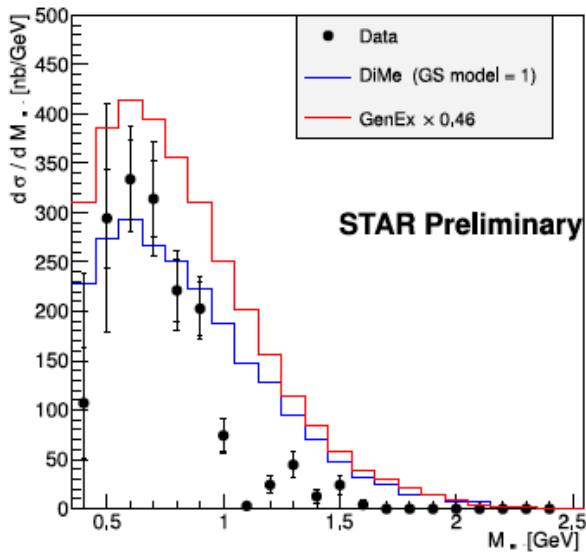
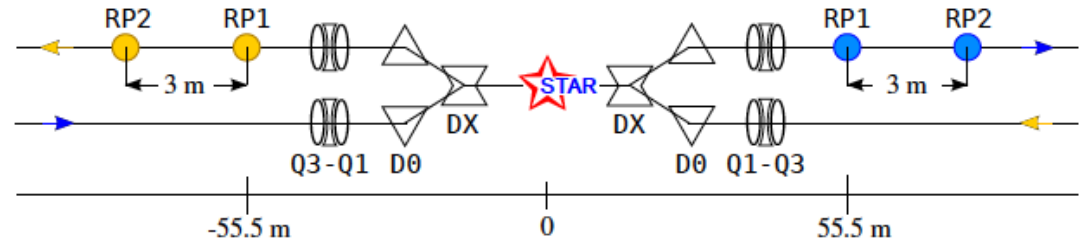

Models of non-resonant $\pi^+\pi^-$ production [2, 3] agree with STAR data up to $\approx 1 \text{ GeV}/c^2$

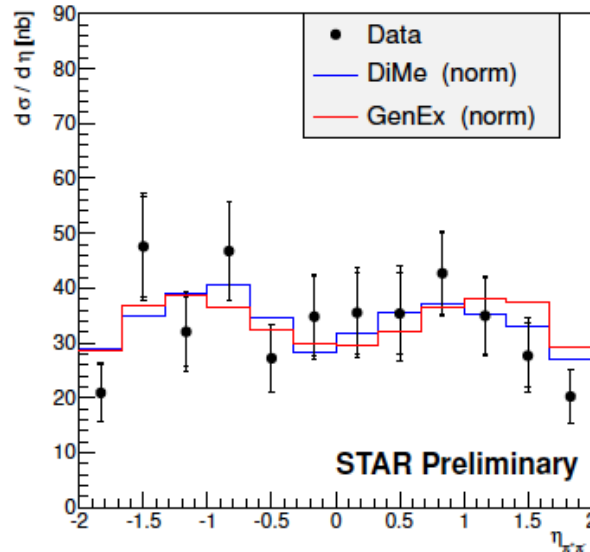

Preliminary cross section in given kinematic range at $\sqrt{s} = 200 \text{ GeV}$
 $\sigma_{\text{CEP}}^{\pi\pi} = 133 \pm 8(\text{stat}) \pm 12(\text{sys}) \text{ nb}$

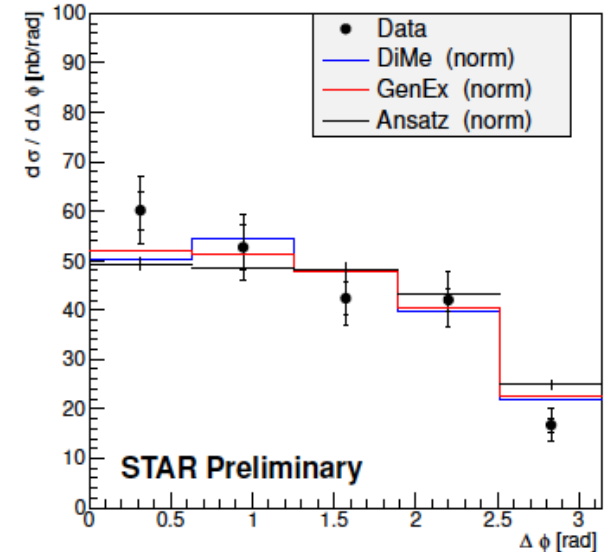

No significant (unexpected) correlation between scattered protons has been found

Details about the results can be found in [10]

Layout of the setup at STAR in 2015 and beyond

In this configuration CEP program is able to acquire large data samples without special conditions.

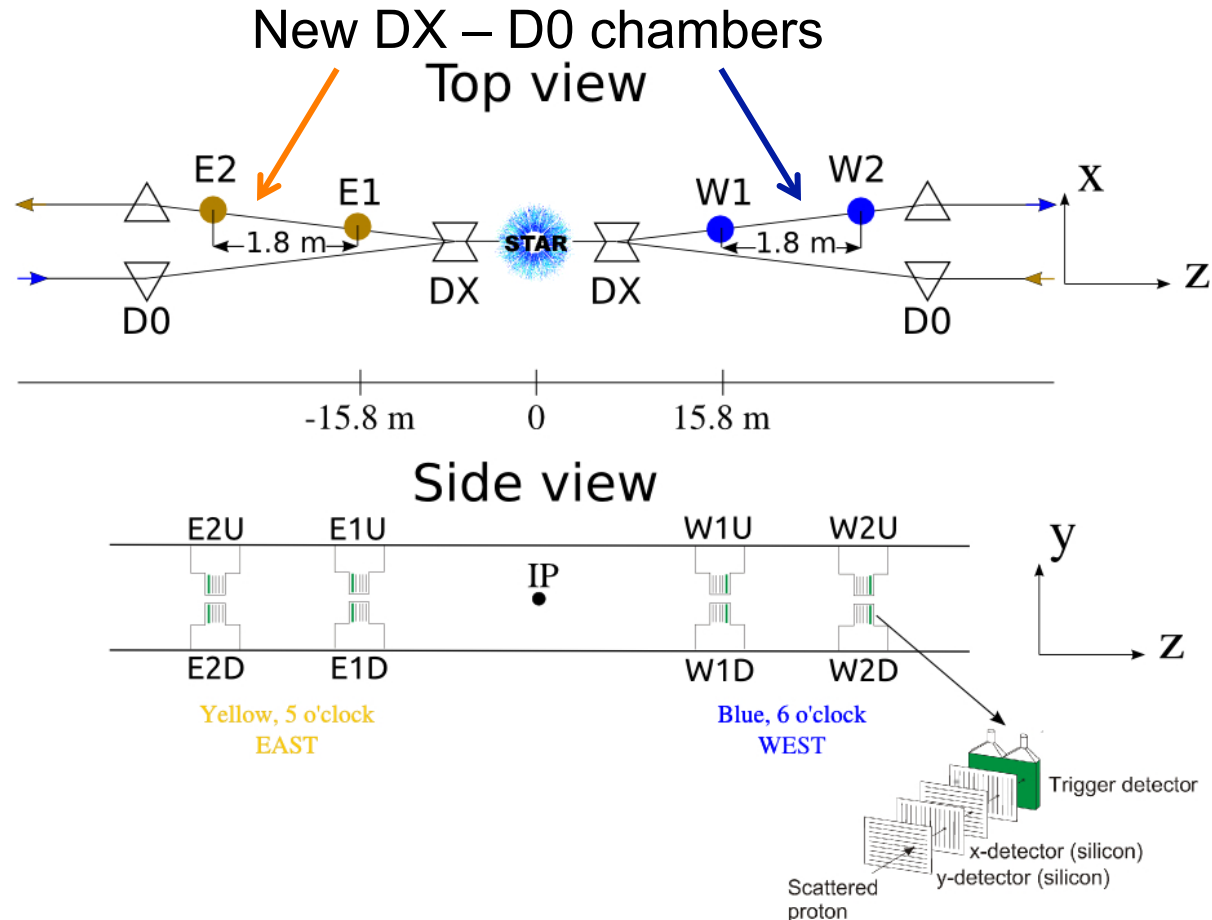

Roman Pot Operation in Just Finished Run 2015

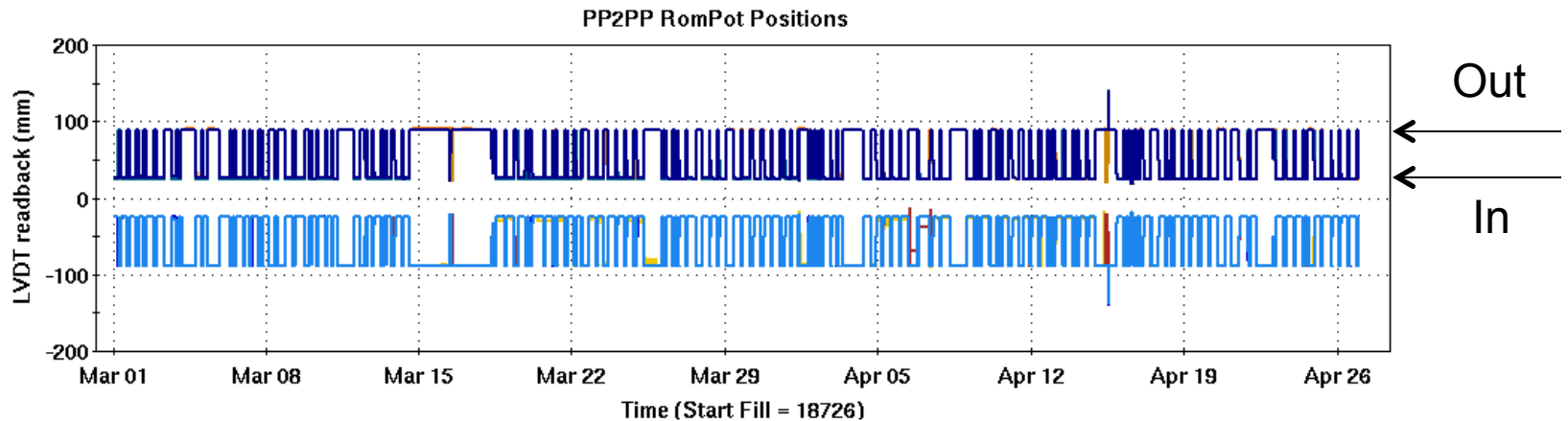
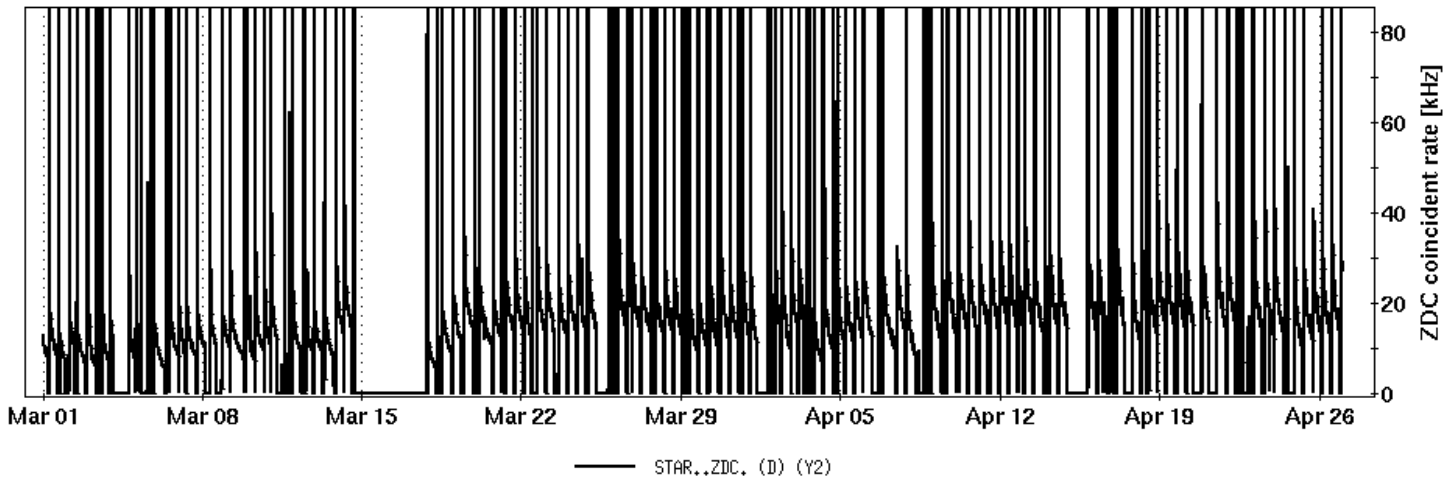

Routine operation of Roman Pots at $\approx 8\sigma_y$ of the beam

Data sample in Run 2015

- Collected 6×10^8 CEP triggers in polarized proton - proton collisions with transverse and longitudinal proton polarization
- Integrated luminosity: $\approx 18 \text{ pb}^{-1}$
- Trigger conditions for CEP events:
 1. At least 2 hits in Time-of-Flight detector (to ensure presence of charged tracks in TPC)
 2. Signal in trigger counters in at least 1 Roman Pot at both STAR sides (detecting diffractive protons)
 3. Veto on signal in small BBC tiles covering $3.3 < |\eta| < 5.0$ (rapidity gap)

The preliminary results presented here are obtained with 2.5% of whole collected data sample.

Final STAR results will be based on 40 times larger statistics.

Si Detector Performance Elastic Scattering

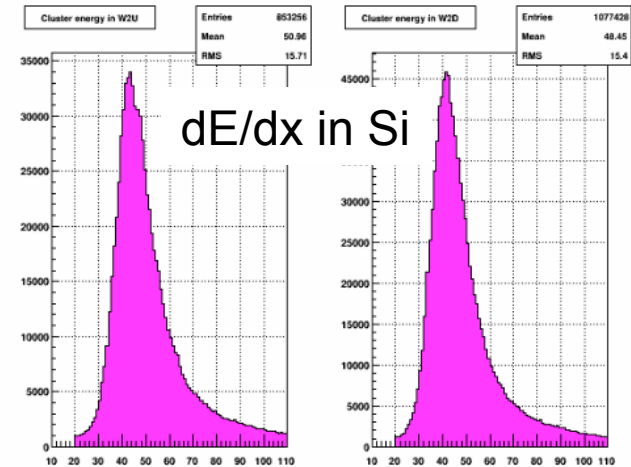
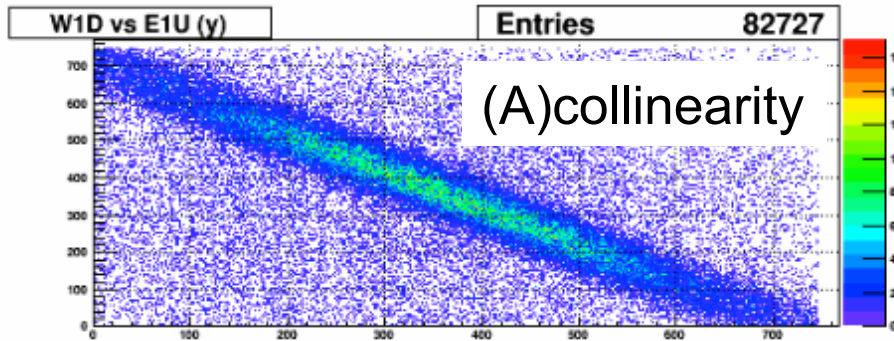

Very good performance of Si detectors:

- Low noise;
- High (> 20) signal to noise ratio;
- High single plane efficiency;
- High proton track reconstruction efficiency.

Geometrical Acceptance of the STAR experiment at $\sqrt{s} = 200$ GeV

- Majority of protons in exclusive $\pi^+\pi^-$ production have very low momentum loss $\xi < 0.05$
- Acceptance in $-t$ range $[0.03, 0.3]$ (GeV/c)²

Fractional momentum loss of protons in $p + p \rightarrow p + \pi^+ + \pi^- + p$
not acceptance-corrected, statistical errors only

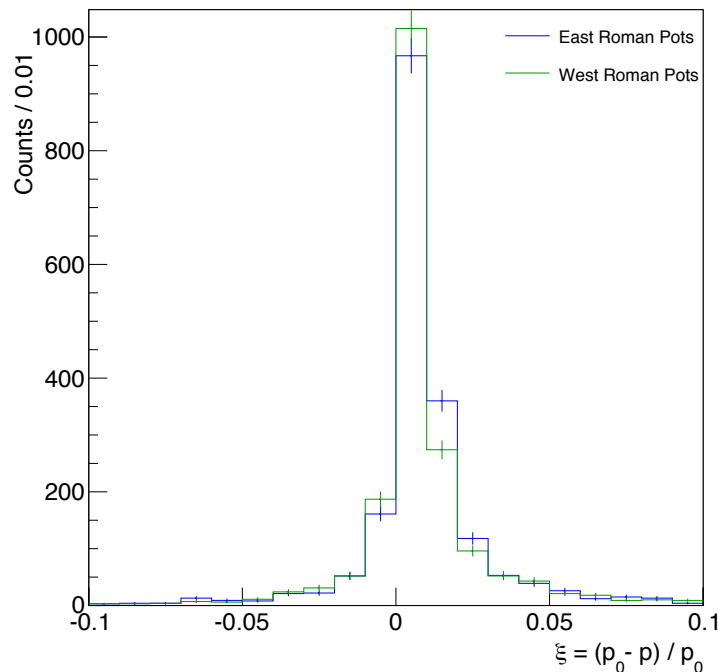

Four-momentum transferred squared in $p + p \rightarrow p + \pi^+ + \pi^- + p$
not acceptance-corrected, statistical errors only

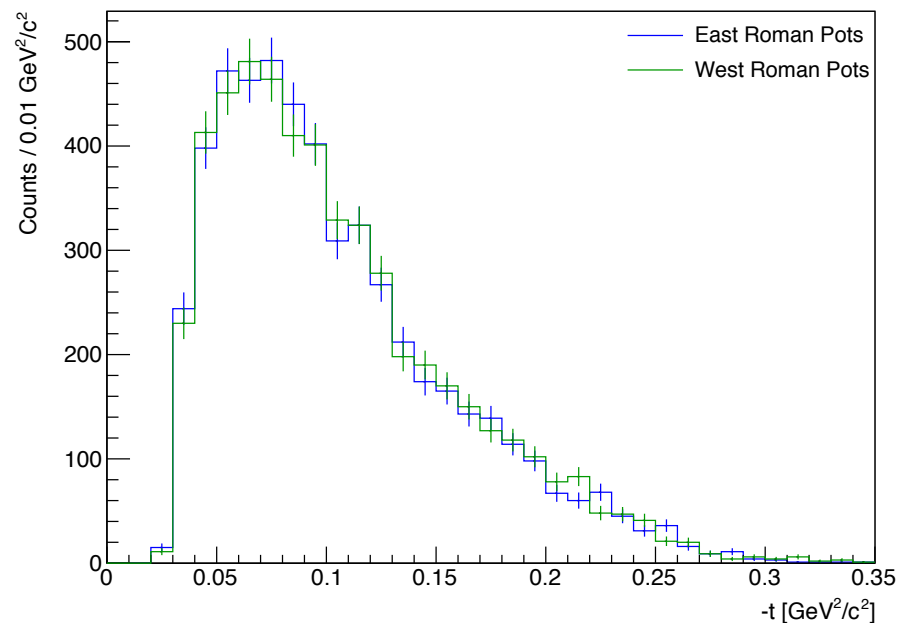

(Preliminary) Data Analysis

Events selection for CEP analysis of two charged meson

- Exactly 2 opposite-sign tracks in TPC matched with hits in Time-of-Flight detector
- Consistence between z-component of vertex measured in TPC and the time of protons detection in Roman Pots (to remove overlap of elastic scattering with minimum-bias events)

$$|z_{\text{vtx}}^{\text{TPC}} - z_{\text{vtx}}^{\text{RP}}| < 3\sigma$$

- Protons (consistent with $\xi = 0$) not collinear (to remove elastic events as described above)

$$\left| \vec{p}_1 + \vec{p}_2 \right|_T > 60 \text{ MeV} / c$$

- Veto in large BBC tiles ($2.1 < |\eta| < 3.3$) to confirm rapidity gap;
- Particle ID determined by $(dE/dx - dE/dx_{\pi, \text{K}}) < 3\sigma$
- Momentum balance between central system MX and protons measured in the Roman Pots

CEP $\pi^+\pi^-$ Sample: Missing Momentum

Detection and momentum reconstruction of all final state particles provides the ability to ensure exclusivity of the system via momentum balance check

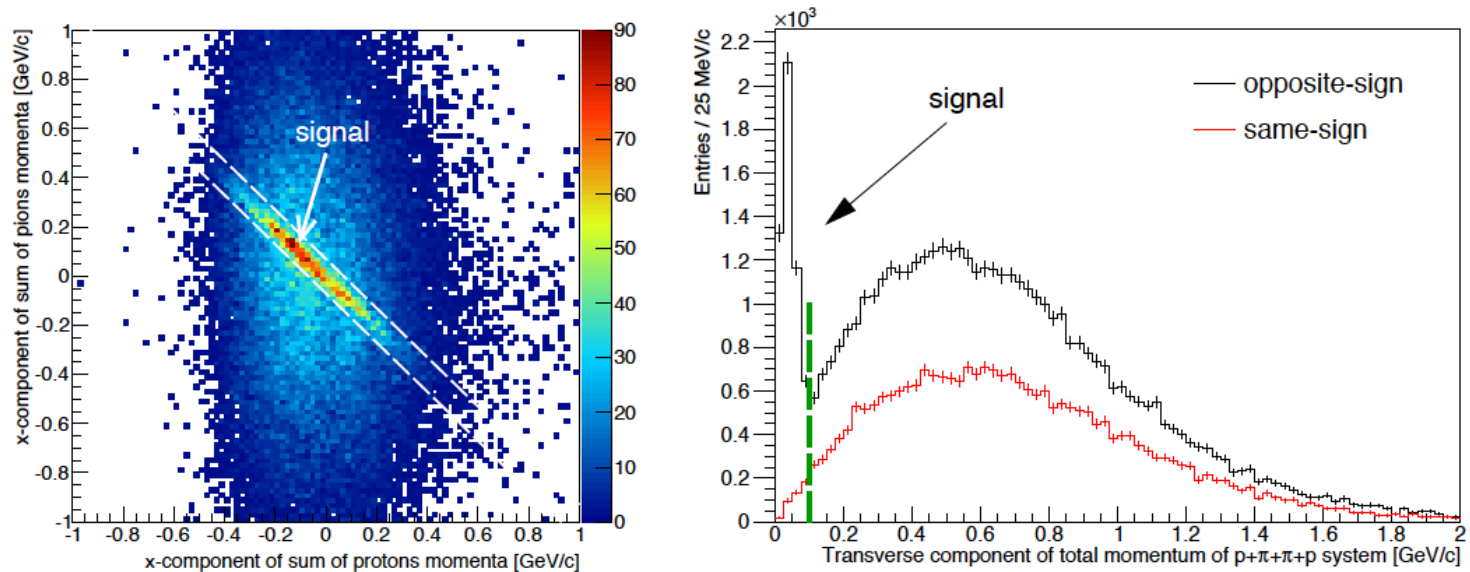

Invariant Mass Distribution $M_X(\pi\pi)$

Invariant mass of $\pi\pi$, $p_T^{\text{miss}} < 0.1 \text{ GeV}/c$, not acceptance-corrected, statistical errors only

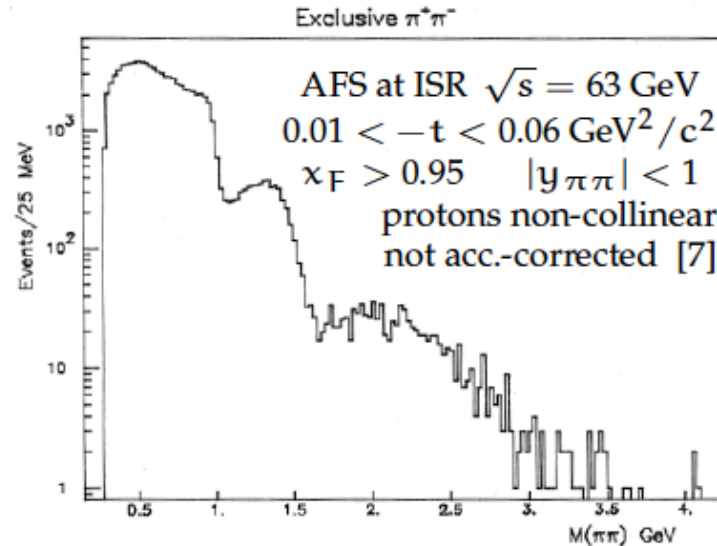
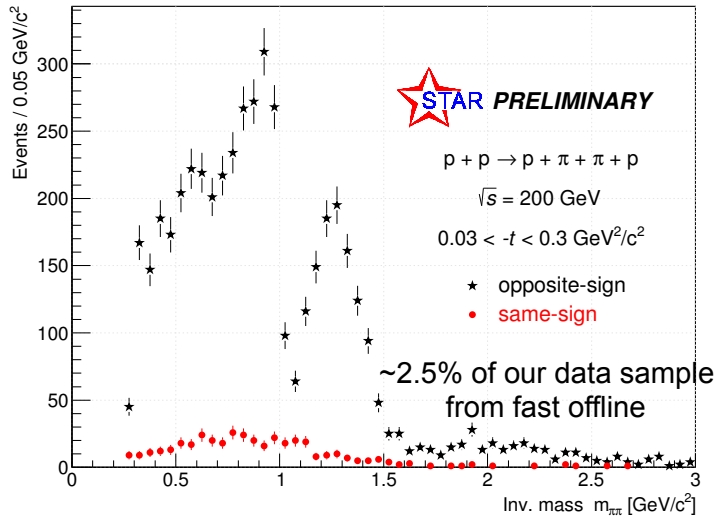

Small Background after momentum balance cut!

1. broad structure extending from $\pi^+\pi^-$ threshold to approximately $1 \text{ GeV}/c^2$;
2. sharp drop around $1 \text{ GeV}/c^2$ (at about $1 \text{ GeV}/c^2$);
3. resonance-like structure between $1-1.5 \text{ GeV}/c^2$;

$\sim 70\text{K}$ events expected for $M_X(\pi^+\pi^-) > 1 \text{ GeV}/c^2$

Compare with CDF Result on $\pi^+\pi^-$ Central Production

(M. Žurek at this Conference)

Invariant mass of $\pi\pi$, $p_T^{\text{miss}} < 0.1$ GeV/c, not acceptance-corrected, statistical errors only

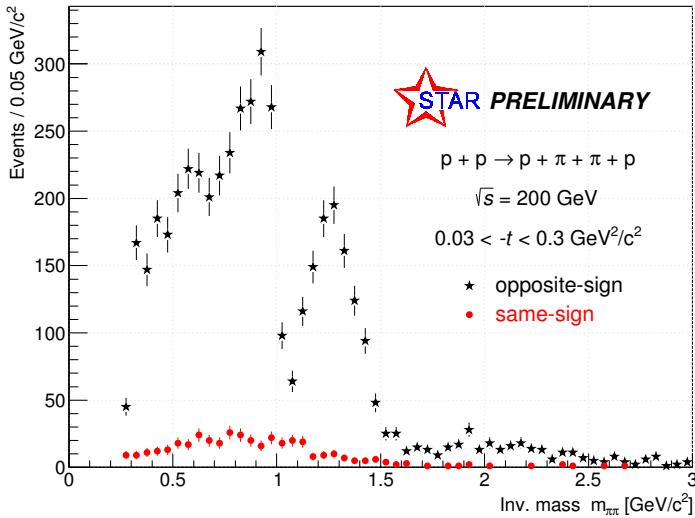

$$pp \Rightarrow p + \pi^+ \pi^- + p$$

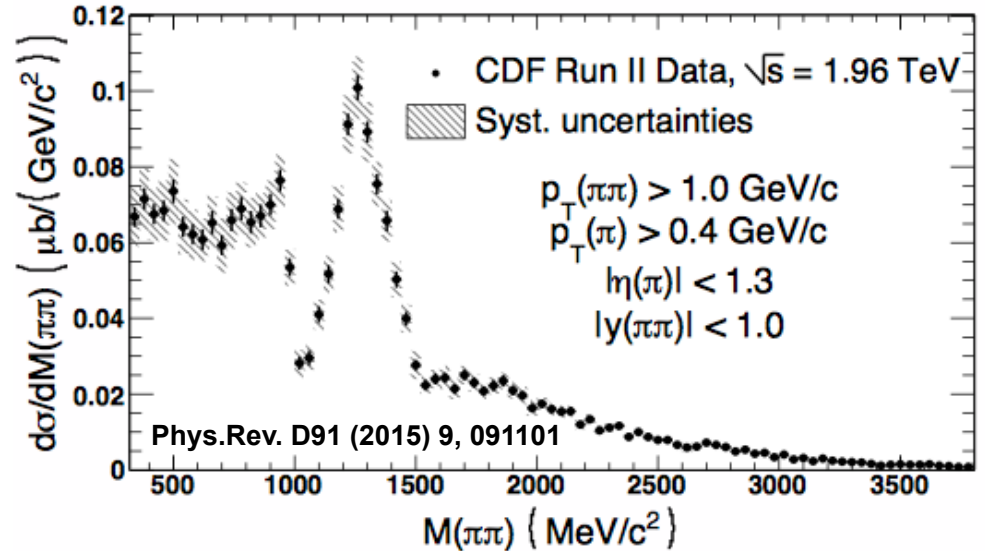

$$p\bar{p} \Rightarrow \text{gap} \oplus \pi^+ \pi^- \oplus \text{gap}$$

Note that STAR essential features are the same as at other colliders
 Similar spectrum found by AFS at ISR (pp) and
 by CDF ($p\bar{p}$, no $p\bar{p}$ tagging \rightarrow rapidity gap method)

Invariant Mass Distribution $M_X(KK)$

Invariant mass of KK, $p_T^{\text{miss}} < 0.1 \text{ GeV}/c$, not acceptance-corrected, statistical errors only

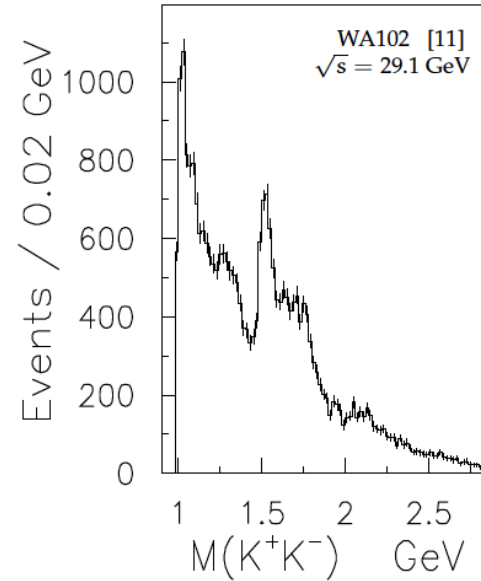
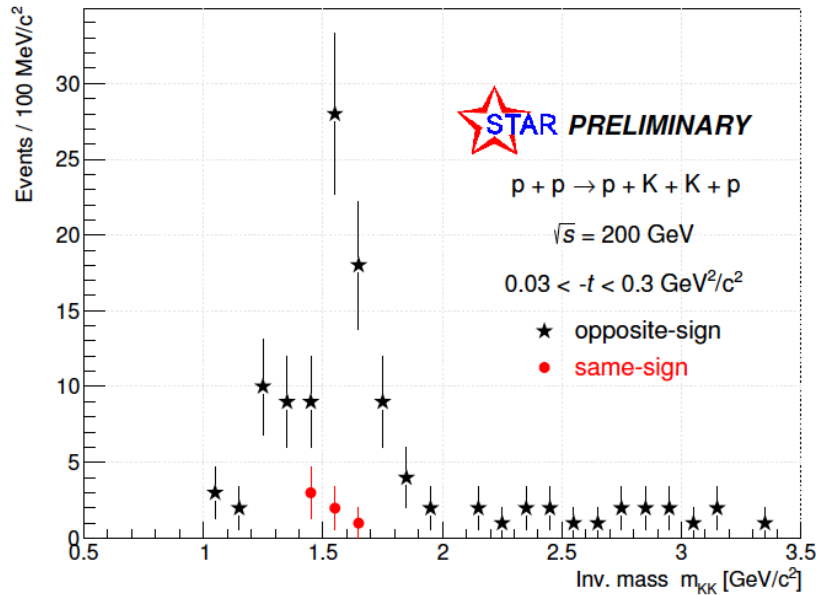

- prominent peak around 1.5-1.6 GeV/c
- some enhancement at f2(1270)/f0(1370) region)
- In spectrum measured by WA102 (fixed target) there is significant contribution from f0(980) not seen by STAR (most probably an effect of limited acceptance at low masses (low K pT))

Expect $\sim 10^4$ exclusive K^+K^- events at full statistics allowing measurement of cross-section and Partial Waves Analysis.

Summary

1. STAR experiment at RHIC has suitable conditions to study diffractive physics, which has been demonstrated i.a. by CEP measurement with Roman Pot Phase I.
2. We had a very successful data taking run in 2015 both pp and pA.
3. Routine operation of Roman Pots at $\approx 8\sigma_y$ of the beam was achieved.
4. In 2015 STAR collected large sample of high quality CEP-dedicated data, whose 2.5% sub-sample was used to prepare presented preliminary mass distributions of exclusively produced pion and kaon pairs.
5. We are looking forward to proton-proton data run in 2017 at $\sqrt{s} = 510$ GeV will be collected (larger kinematic region) hence comparison of results from two energy regimes will be possible.