

STAR Run 23 Report

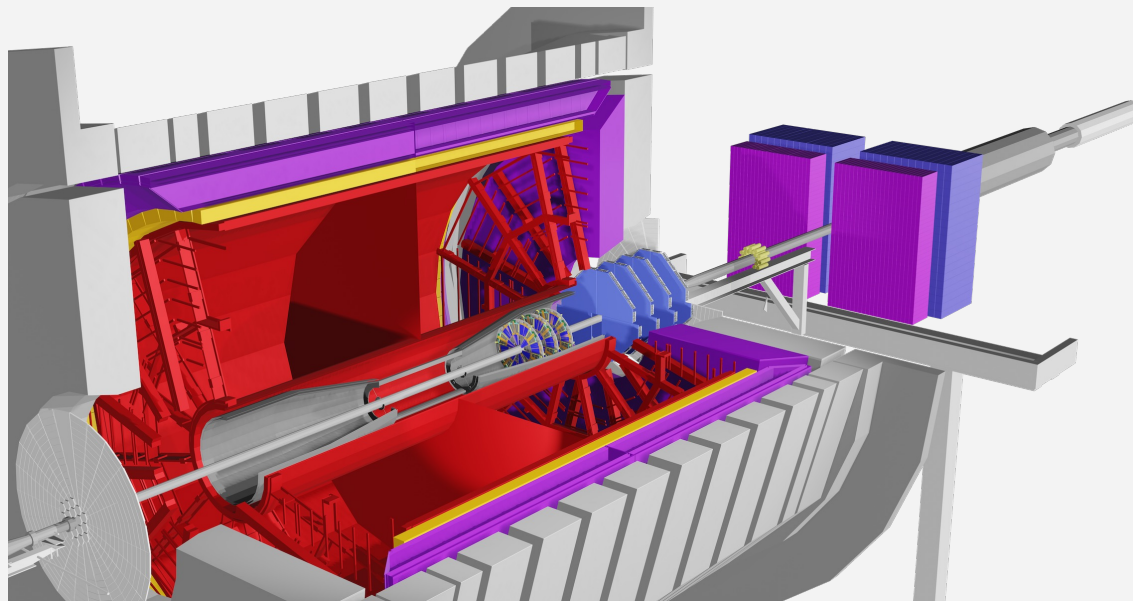

**Experimental operation of
Run-23 Au+Au at 200 GeV:**

- ✓ Achievements
- ✓ Upgrades
- ✓ Unexpected issues

Supported in part by



U.S. DEPARTMENT OF
ENERGY

Office of
Science

- *Kong Tu, BNL
for the STAR Collaboration*

Strongly interacting QCD at the precision frontier

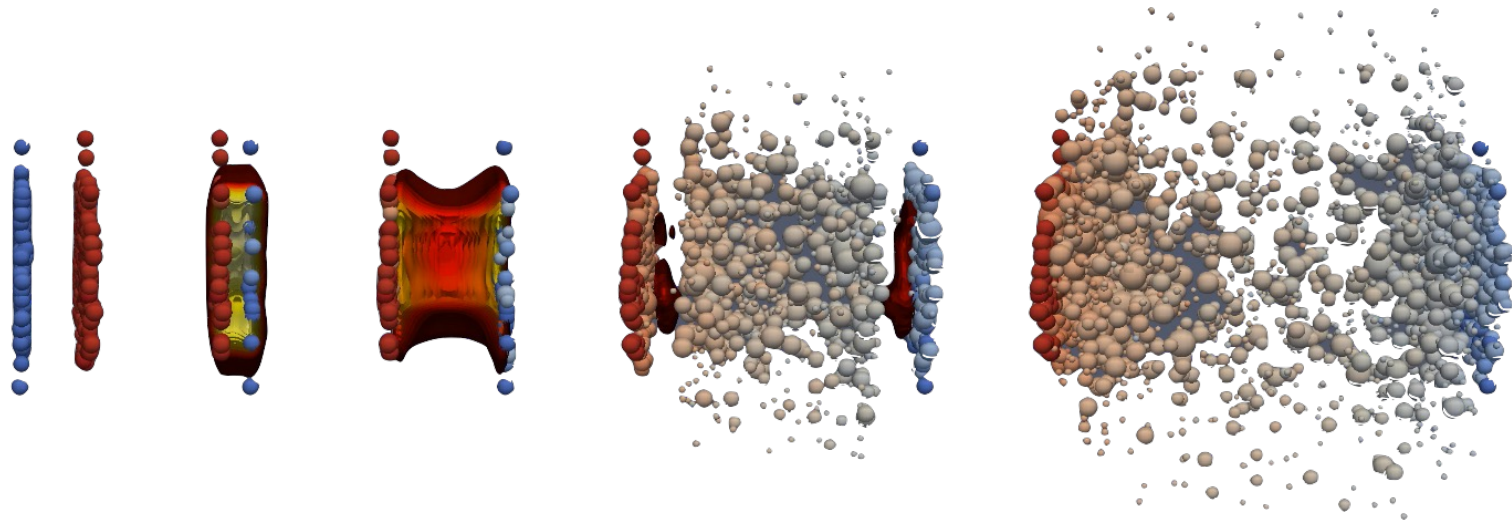

*First top energy Au+Au run
with iTPC & forward detectors!*

- Microstructure of the QGP.
- Initial state dynamics.
- Medium properties.
- Final state dynamics.

*See Rongrong Ma's talk later
to learn more about the
hot and cold QCD physics.*

As of today: recorded 6.5B events.

zdc_mb

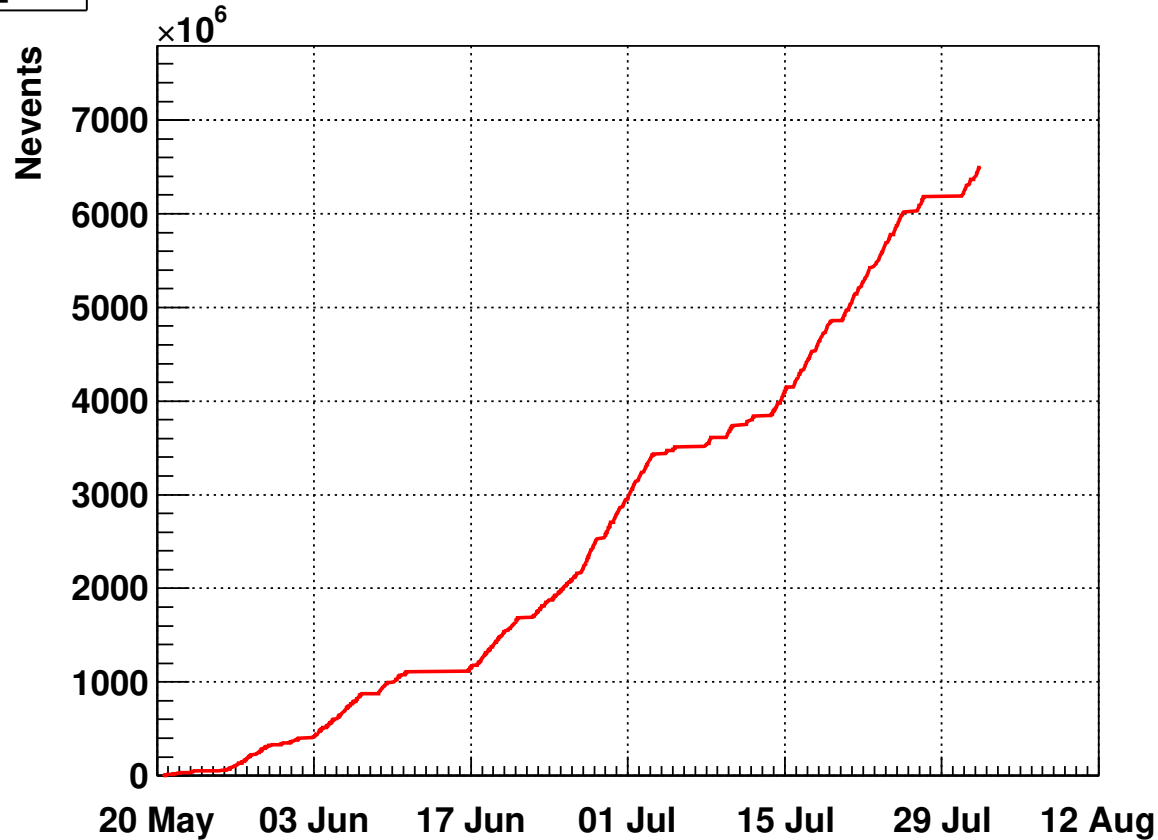

Wed Aug 2 10:07:03 2023

STAR BUR:

$\sqrt{s_{NN}}$ (GeV)	Species	Number Events/ Sampled Luminosity	Year
200	Au+Au	20B / 40 nb ⁻¹	2023+2025
200	<i>p+p</i>	235 pb ⁻¹	2024
200	<i>p+Au</i>	1.3 pb ⁻¹	2024

We are on good track to achieve our goal for collecting data:

20B MB for 2023+2025
High p_T program for 40 nb⁻¹

As of today: recorded 6.5B events.

zdc_mb

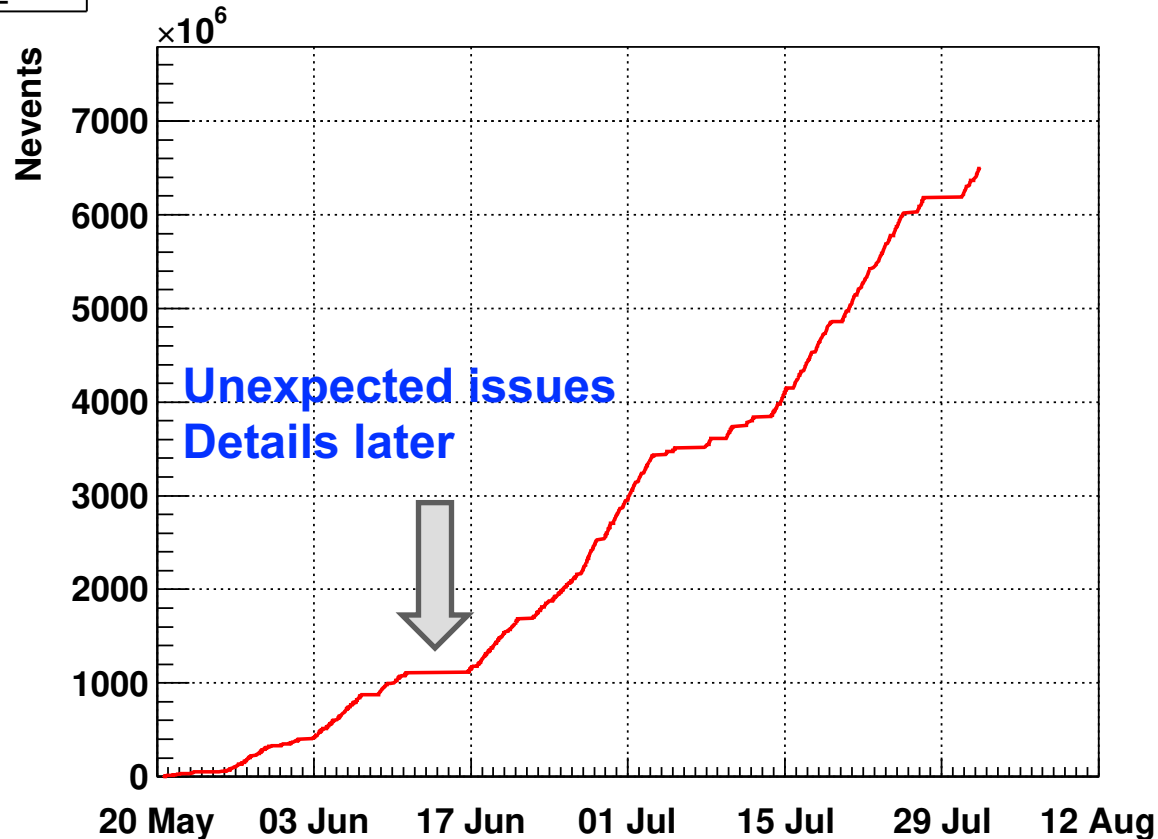

STAR BUR:

$\sqrt{s_{NN}}$ (GeV)	Species	Number Events/ Sampled Luminosity	Year
200	Au+Au	20B / 40 nb ⁻¹	2023+2025
200	<i>p+p</i>	235 pb ⁻¹	2024
200	<i>p+Au</i>	1.3 pb ⁻¹	2024

We are on good track to achieve our goal for collecting data:

20B MB for 2023+2025
High p_T program for 40 nb⁻¹

Wed Aug 2 10:07:03 2023

Data taking performance

Data taking ~ 12h/day

Event rates ~ 150M/day

hours_perday_zdc_mb.txt

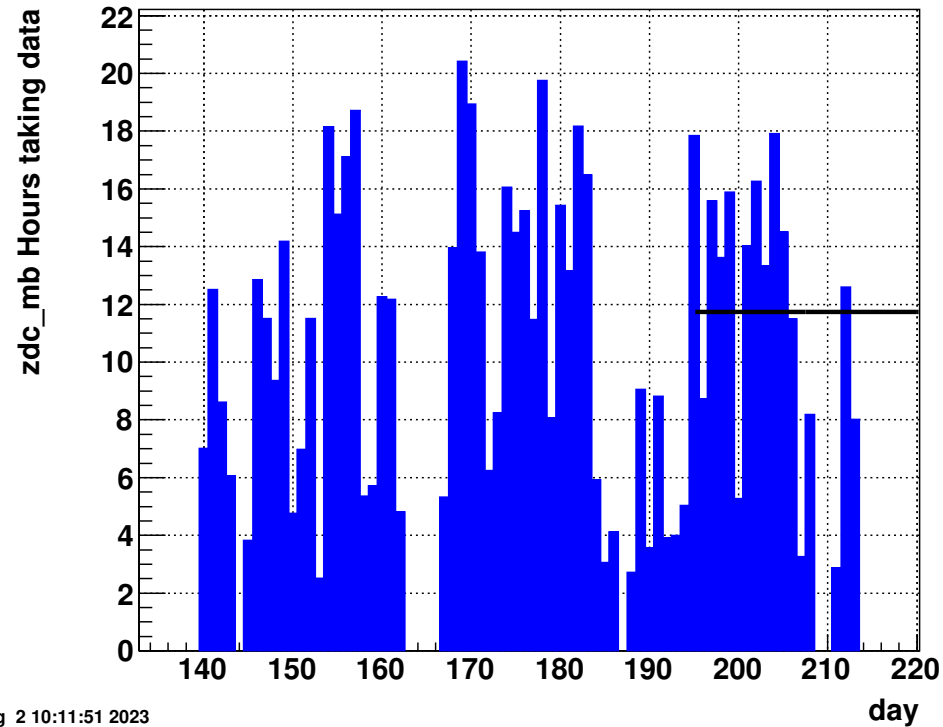

Wed Aug 2 10:11:51 2023

zdc_mb N_events

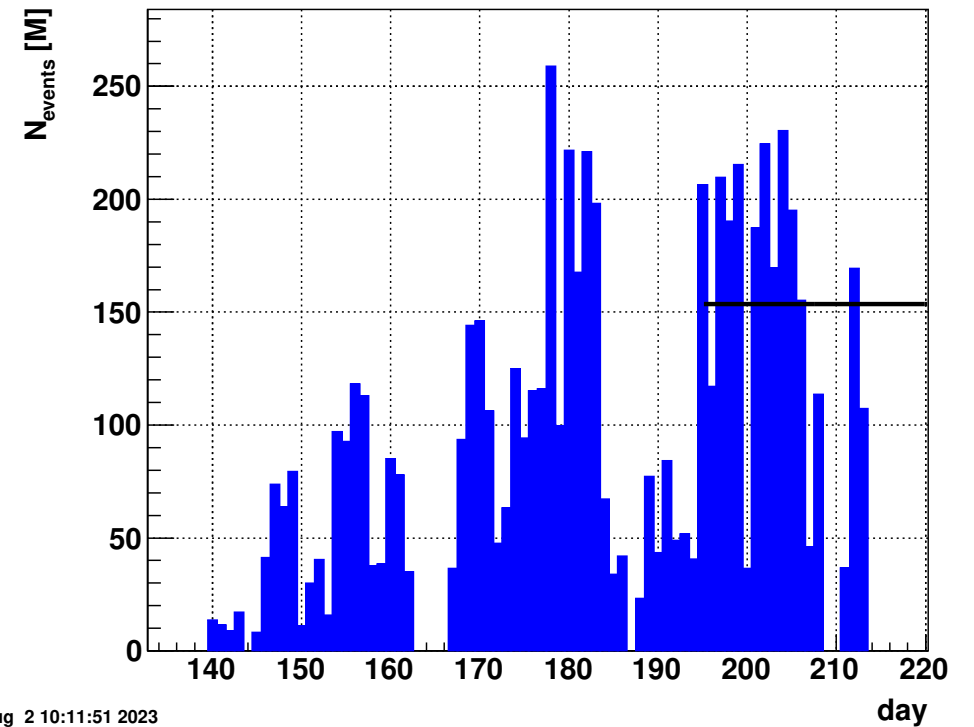

Wed Aug 2 10:11:51 2023

Collisions at STAR (IP6)

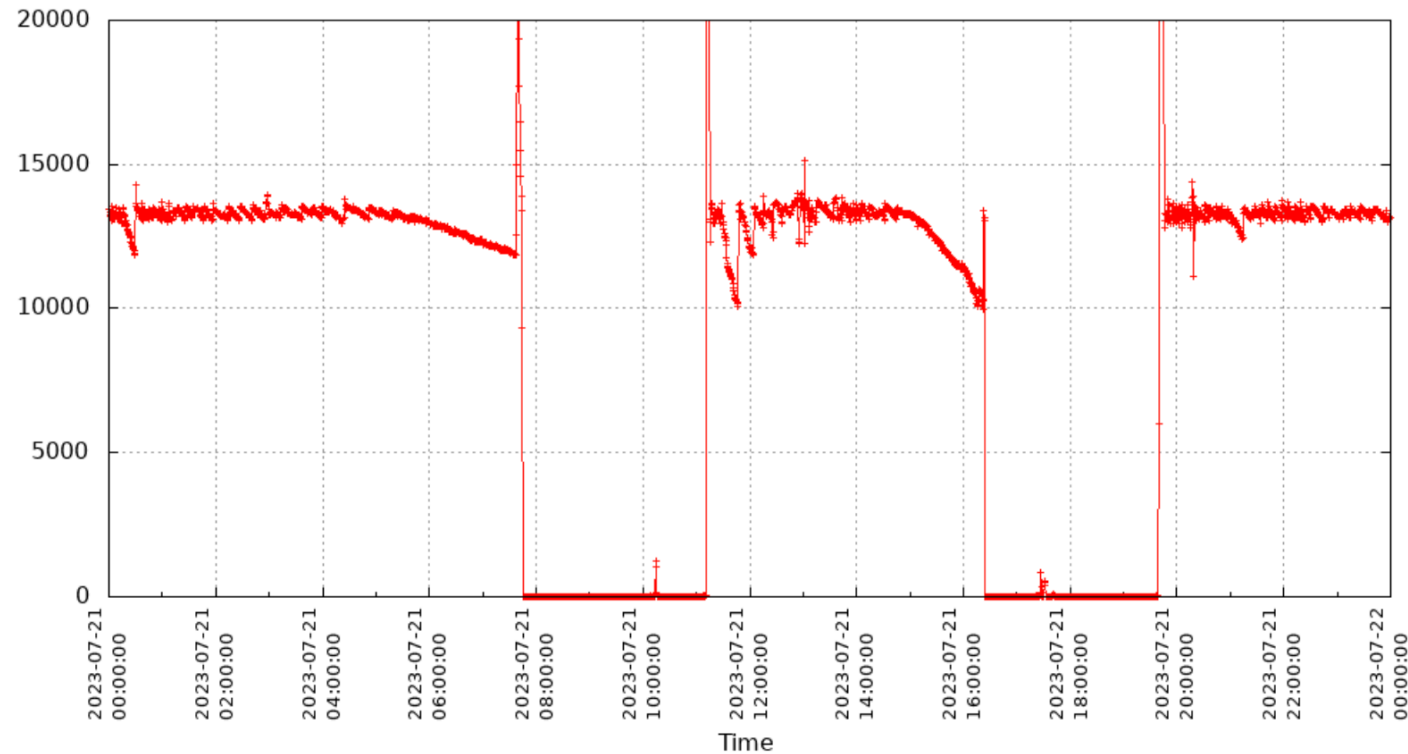

CAD provided: luminosity leveling at around 13 kHz for the ZDC rate.
~ 30% electromagnetic interaction ~70% hadronic interaction.

Crossing angle $\sim 1\text{mrad}$ at IP6

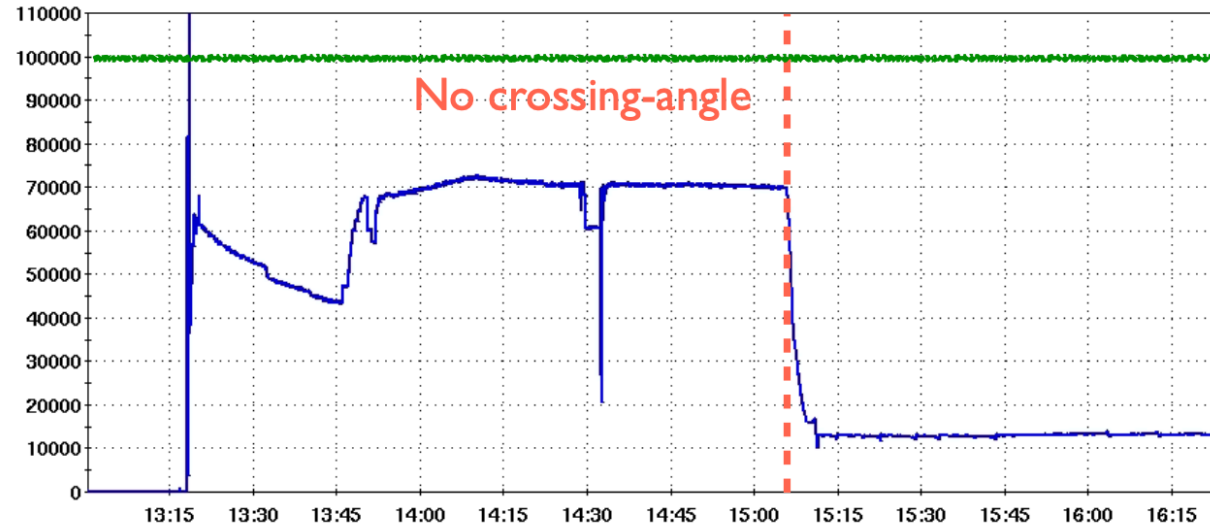

High data quality

ZDC Fill 34004 (7/18)

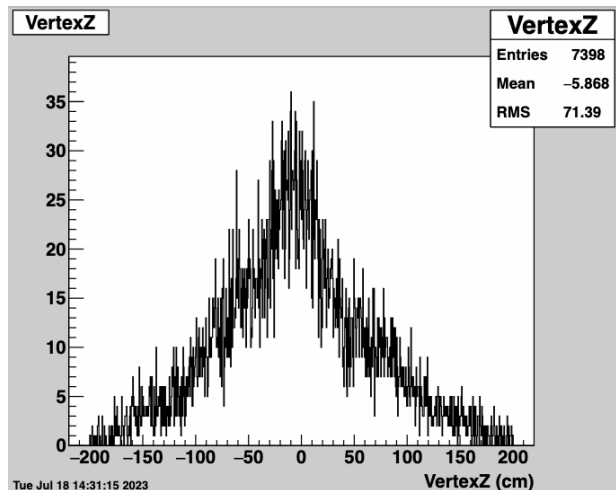

1 mrad crossing angle
`focused` the vertex z

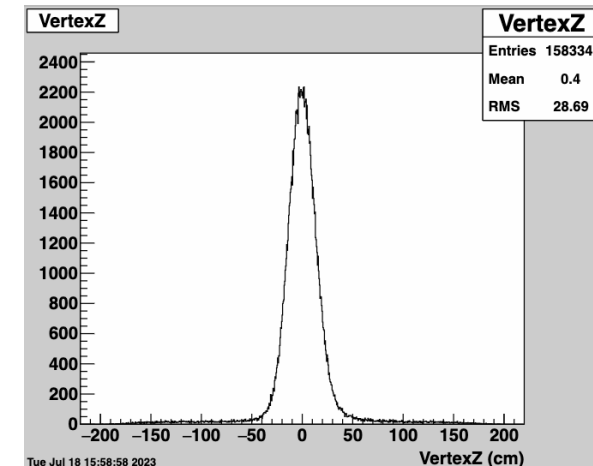
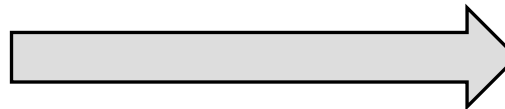

Blue beam backgrounds

*Scalar rates from BBCs

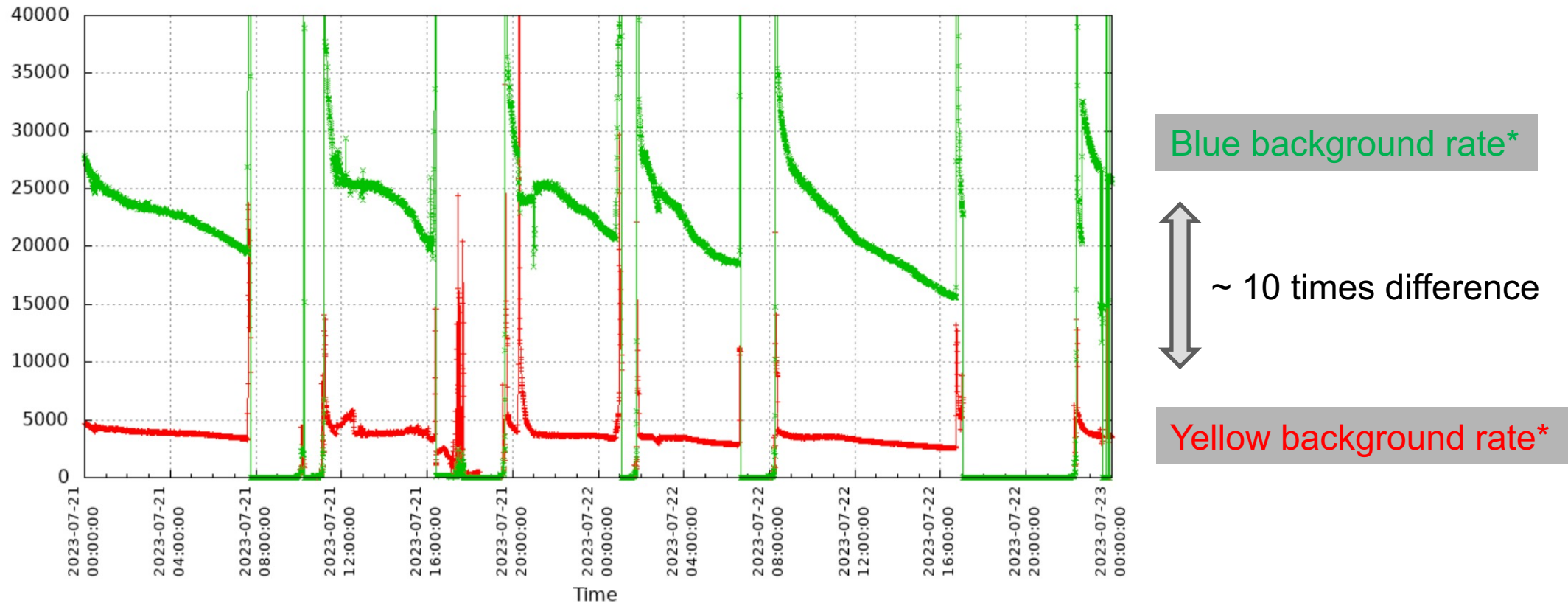

After a few weeks of running, CAD and STAR figured out this is primarily due to the Au⁷⁸ coasting in RHIC, and no prefire protection. (traveling from east to west, from IP6 to IP8)

ZDC coincidence kills this type of background → doesn't impact the main physics trigger

DAQ 5k upgrade

Since mid-June, STAR has fully functional
5 kHz readout DAQ system
 ~ a factor 2 improvement.

Det	State	Dead	CPU	Evts	Evts In	Hz	MB/s EVB	Err	MB/s RDO
TOF	RUNNING	19 %	18 %	8229490	0	5157	27.2	0	26
BTOW	RUNNING	12 %	15 %	8231430	0	5109	50.0	0	50
Trigger	RUNNING	0 %	-1 %	8239119	4	5131	23.5	0	0
ETOW	RUNNING	13 %	15 %	8230275	0	5178	10.9	0	11
BSMD	READY	0 %	0 %	303114	0	0	0.0	0	0
ESMD	READY	0 %	0 %	306476	0	0	0.0	0	0
TPX	RUNNING	55 %	50 %	8239647	12	5175	857.4	2	10354
MTD	RUNNING	12 %	15 %	8230355	0	5189	4.6	0	4
GMT	RUNNING	0 %	13 %	6229	0	2	0.1	0	0
L4	RUNNING	0 %	0 %	-1/620291	56	381	293.3	0	393
ETOF	READY	0 %	32 %	681549	0	0	0.0	0	0
ITPC	RUNNING	55 %	55 %	8239704	26	5177	1455.7	1000	13637
FCS	RUNNING	3 %	24 %	8233751	6	5180	377.8	0	2702
STGC	RUNNING	6 %	7 %	2986709	1	1858	62.0	0	61
FST	RUNNING	6 %	45 %	2986229	2	1841	12.9	0	344

Faster rate of data taking

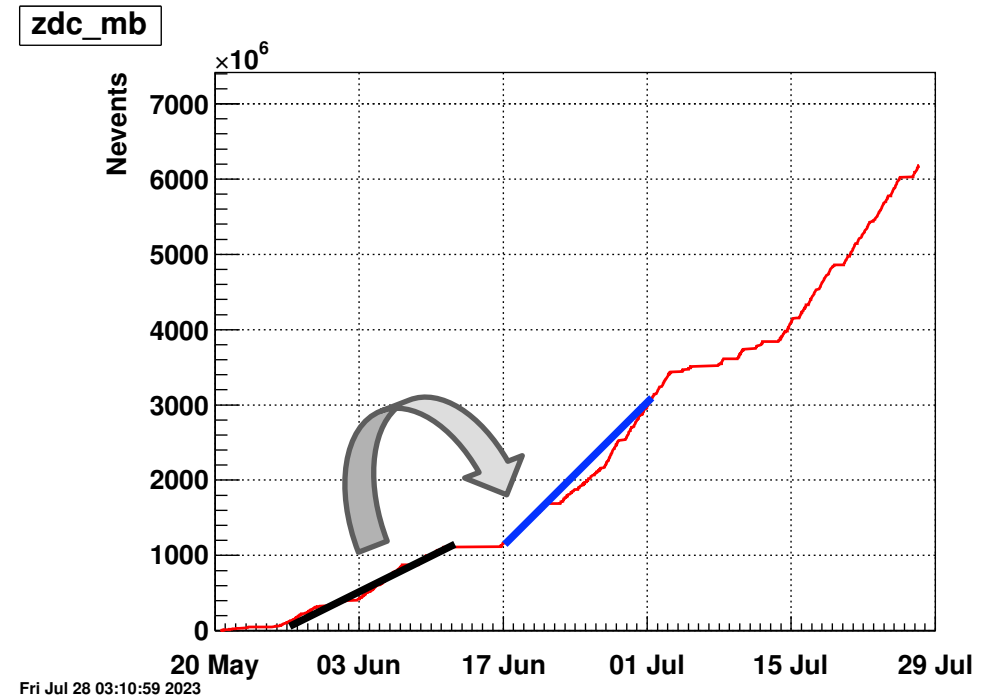

This is a huge improvement for Run-23 STAR data taking

ZDC_MB rates before and after DAQ 5k

nev_rate_perfill_zdc_mb.txt

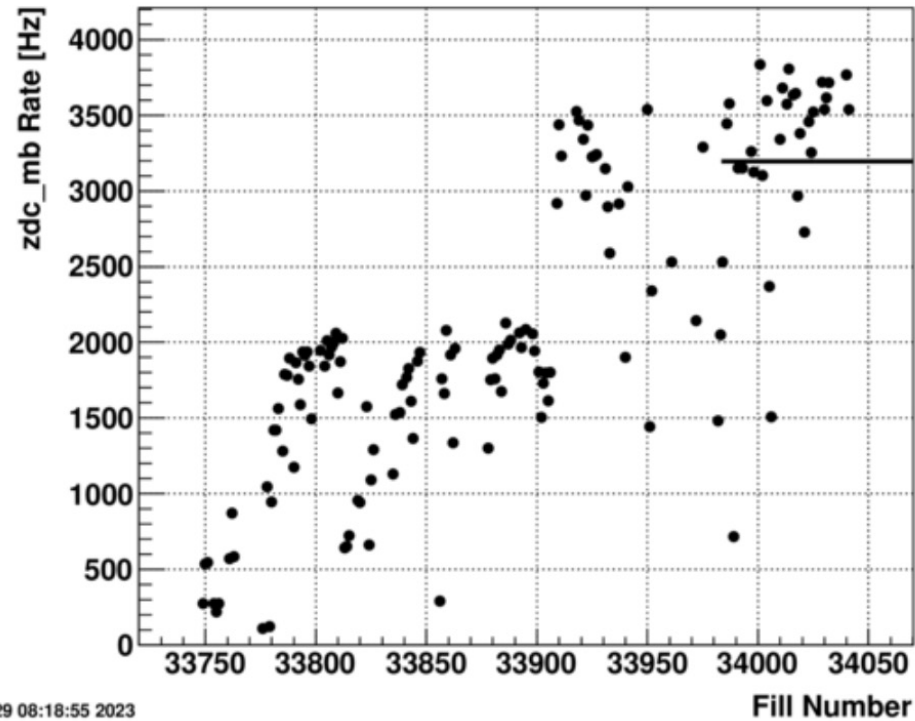

Sat Jul 29 08:18:55 2023

zdc_mb Average Rate [Hz]

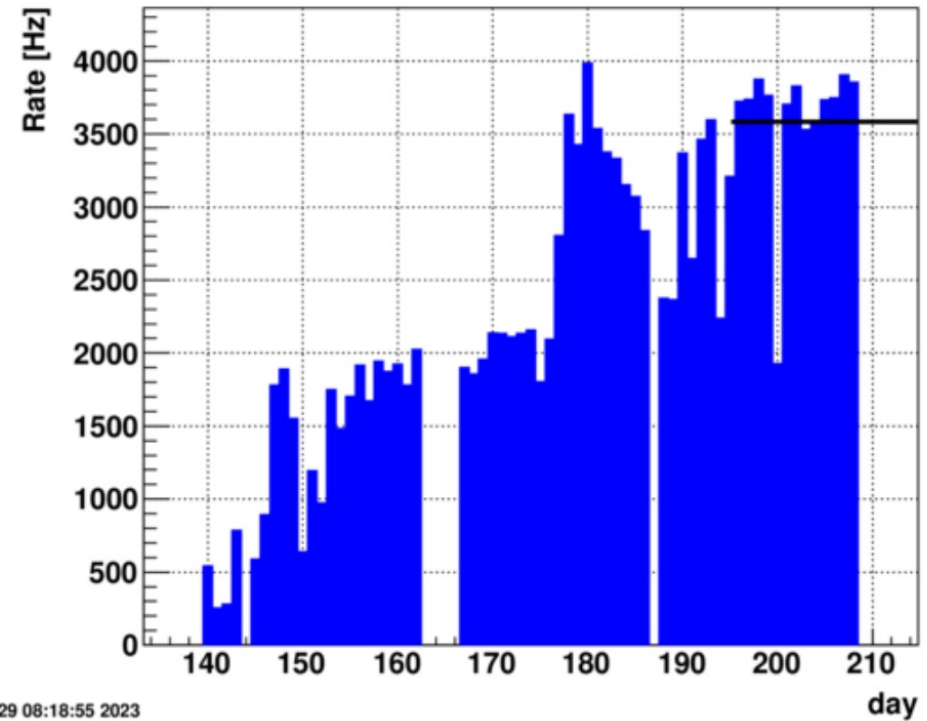

Sat Jul 29 08:18:55 2023

Triggers

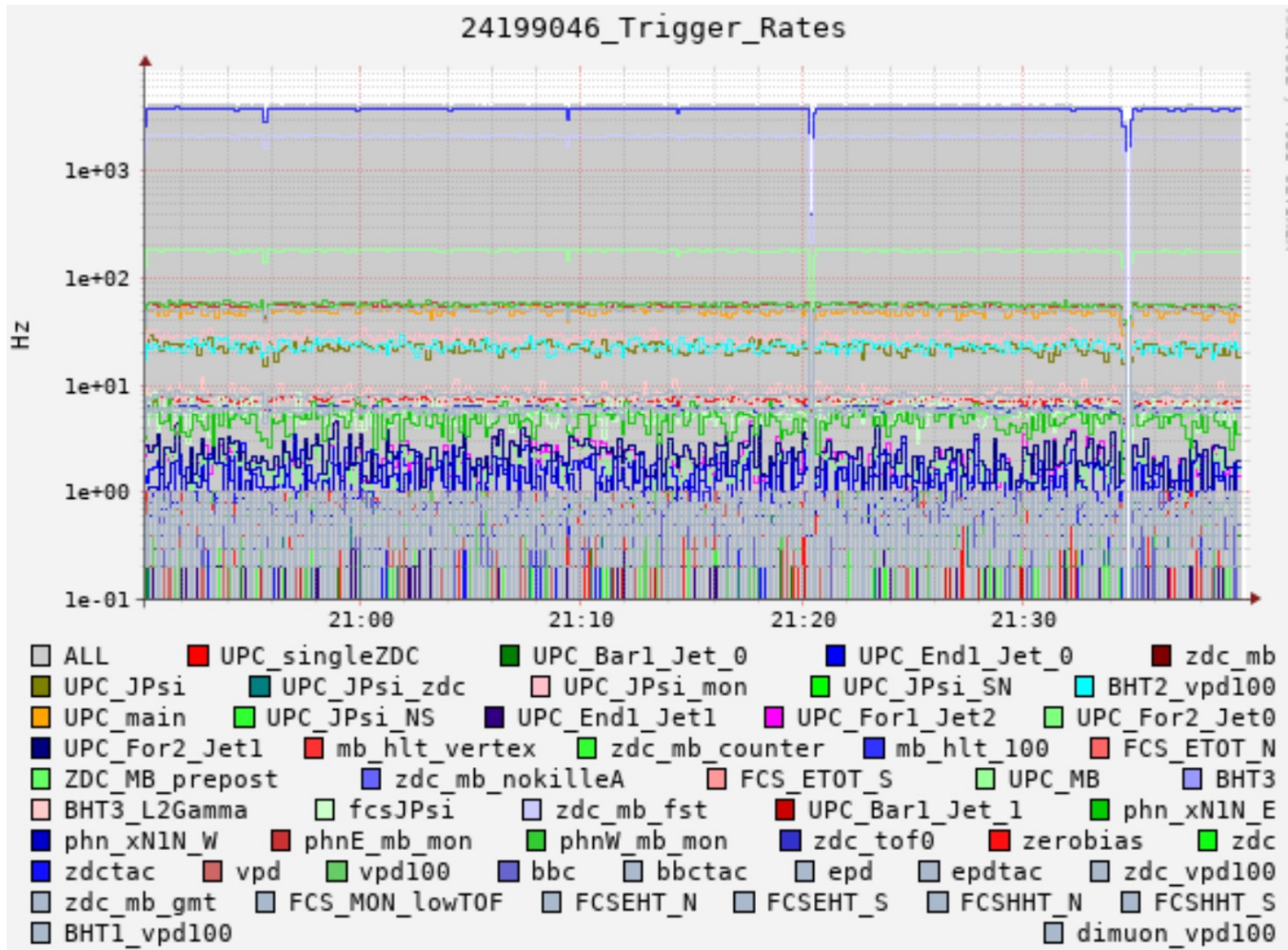

Besides the MB triggers, we have added new triggers this year for UPC physics program, including triggers based on the **forward detector system!**

Large ZDC_mb data with non-hadronic collisions
 – (photon physics, **UPC photoproduction of ϕ**)

Data QA

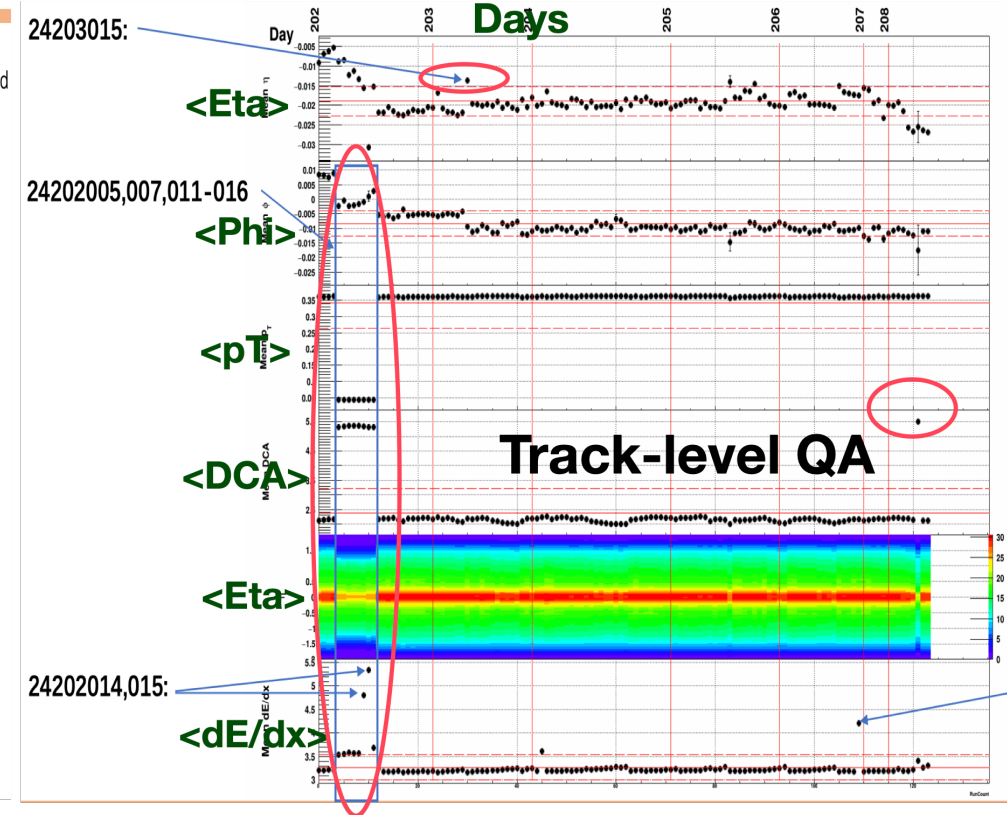
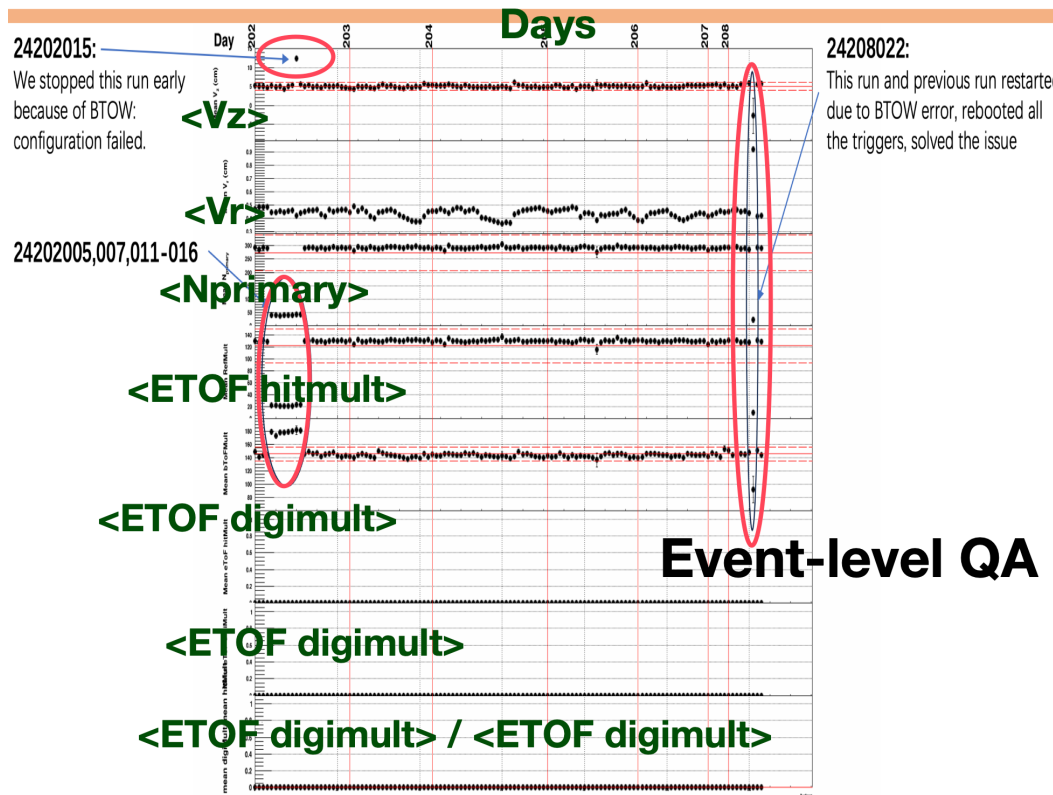

STAR Offline QA team has been working closely to monitor the data quality.

Unexpected issue - Smoke

Air quality impacted by the smoke coming from Canada (wildfires)



(AQI ~ 250)

Situation in early June:

Smokes from the wildfire could trigger the High-Sensitivity-Smoke-Detector (HSSD);

HSSD is part of the STAR operation safety envelope.

BNL decided to shut down all HSSDs and therefore, STAR was shut down for 1 day. (LOTO – Lock-out-tag-out)

Unexpected issue - Smoke

Air quality impacted by the smoke coming from Canada (wildfires)



(AQI ~ 250)



Unexpected issue – Cooling

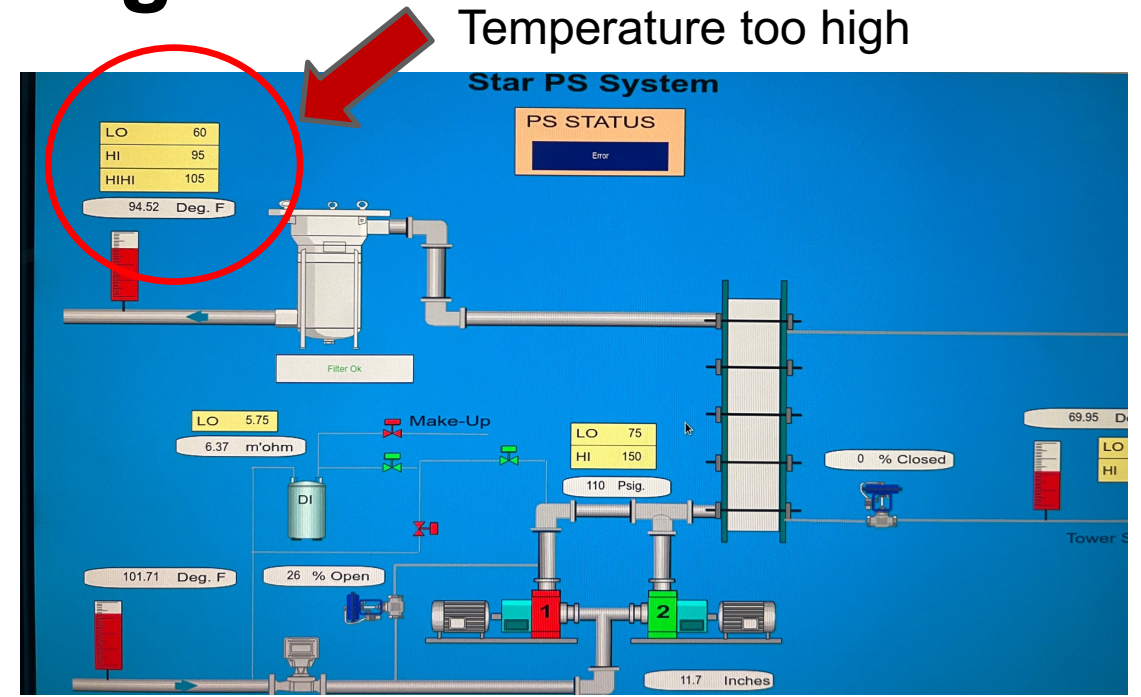
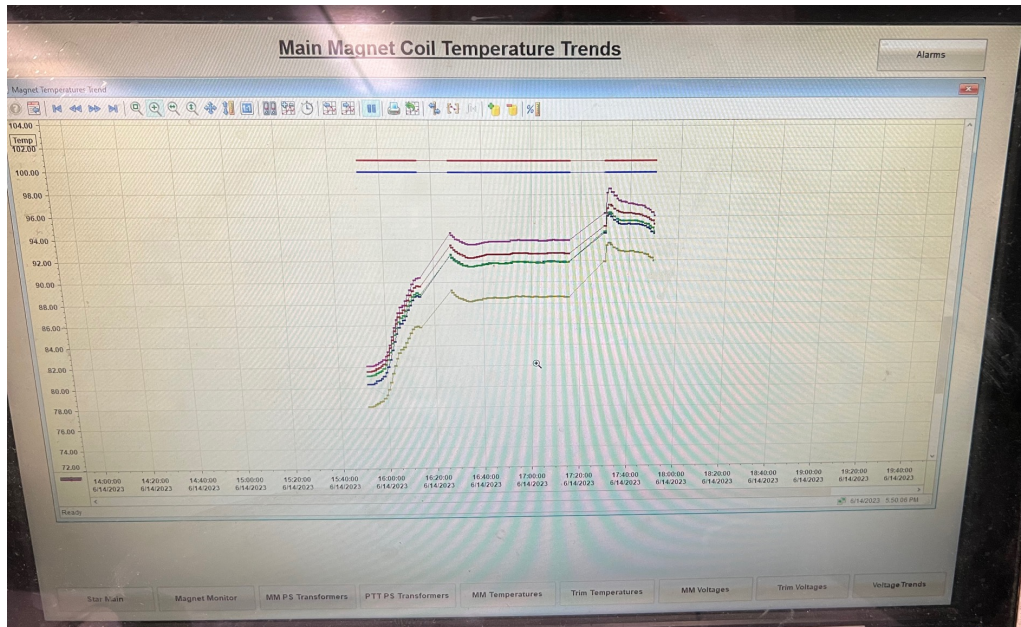

- STAR magnet in mid-June started to trip very frequently.
- Overheat and found issues in the cooling system.
- Fixed issues and turned on the STAR chiller
- Fixed issues (cleaning) for the heat exchanger (multiple systems)

Unexpected issue – Cooling



Dirty side

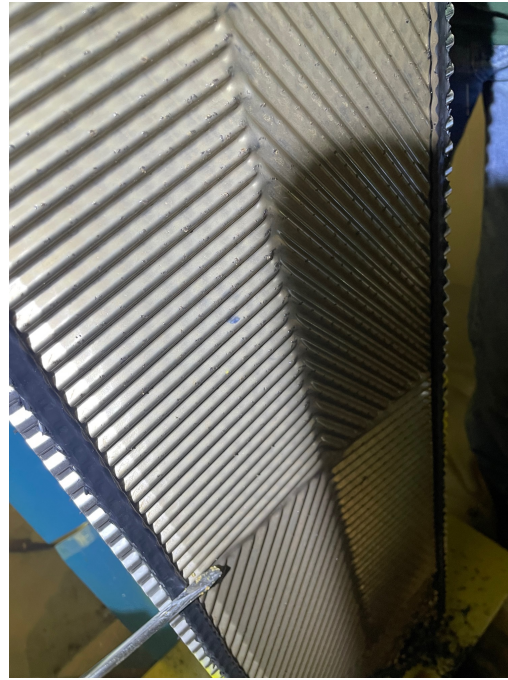

Clean side



Gunk stuck in the heat exchanger

Big thanks to the support team (led by David Chan) to clean the heat exchangers, esp over the Juneteenth long weekend.

Projection to the end of Run-23:

zdc_mb

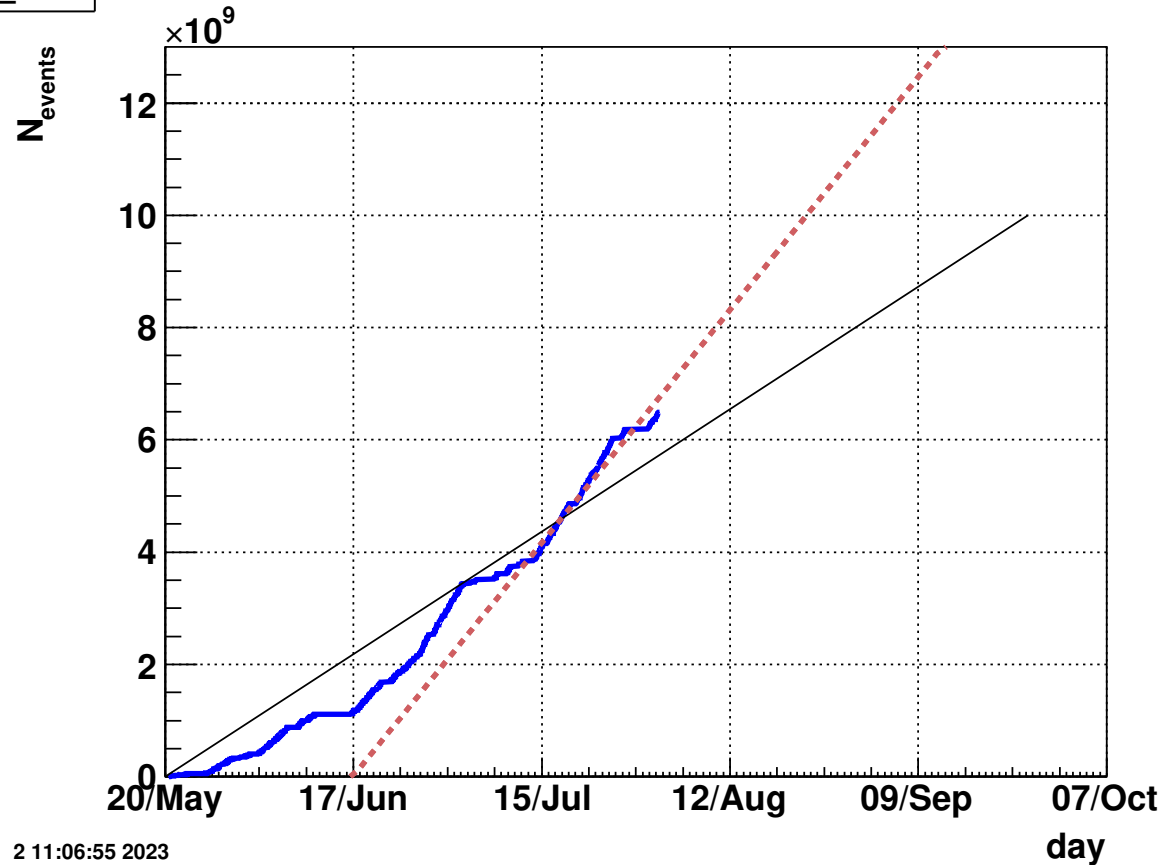

STAR BUR:

$\sqrt{s_{NN}}$ (GeV)	Species	Number Events/ Sampled Luminosity	Year
200	Au+Au	20B / 40 nb ⁻¹	2023+2025
200	<i>p+p</i>	235 pb ⁻¹	2024
200	<i>p+Au</i>	1.3 pb ⁻¹	2024

We may have to stop the run 23 due to helium leak issue. But our goal remains:

20B MB for Run23-25

High p_T program for 40 nb⁻¹

Run 24: STAR requests significant ***p+p* and *p+Au* data taking**. Important program for Saturation, GPD measurements, etc.

Summary

We would like to thank CAD, all the STAR collaborators, and the BNL management for this run, especially given the challenge of running RHIC through the summer!

