



Recent Transverse Spin Measurements in pp Collisions with *STAR*

Carl Gagliardi

Texas A&M University

for the *STAR* Collaboration

Outline

- Introduction
- Recent (and near future) measurements
- *STAR* Forward Upgrade plans



U.S. DEPARTMENT OF
ENERGY

Office of
Science

Complementarity of DIS and p+p

- **Deep-inelastic scattering** primarily probes via:

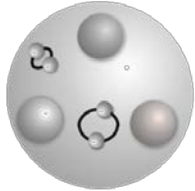

- Electromagnetic interactions

- Couple to charge²
- Insensitive to color



- Weak interactions

- Couple to weak charge (~flavor)
- Insensitive to color

- Only accesses gluons through higher-order effects

- **pp collisions** primarily probe via:

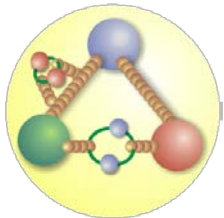

- Strong interactions

- Couple to color charge
- Direct leading-order sensitivity to gluons
- Insensitive to flavor

- **Need both for a consistent and complete picture**
- **Combine DIS and p+p** to explore **universality** and separate **interaction-dependent phenomena from intrinsic properties**

A well-proven method

MSTW 2008

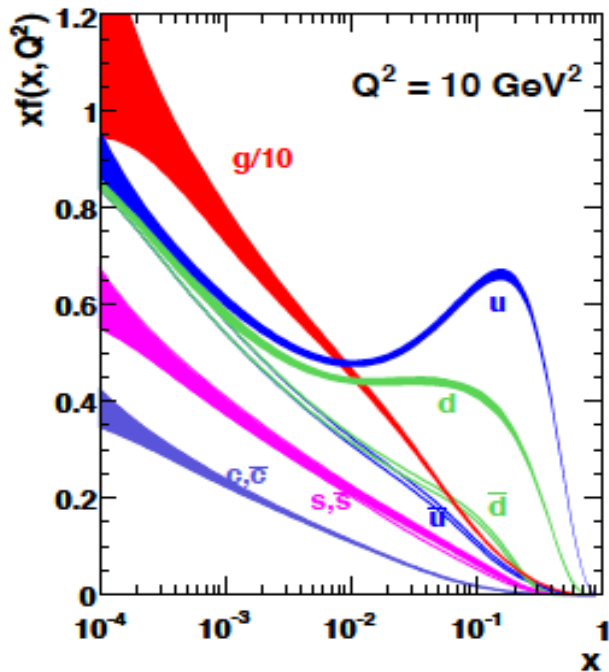

Process	Subprocess	Partons	x range
$\ell^\pm \{p, n\} \rightarrow \ell^\pm X$	$\gamma^* q \rightarrow q$	q, \bar{q}, g	$x \gtrsim 0.01$
$\ell^\pm n/p \rightarrow \ell^\pm X$	$\gamma^* d/u \rightarrow d/u$	d/u	$x \gtrsim 0.01$
$pp \rightarrow \mu^+ \mu^- X$	$u\bar{u}, d\bar{d} \rightarrow \gamma^*$	\bar{q}	$0.015 \lesssim x \lesssim 0.35$
$pn/pp \rightarrow \mu^+ \mu^- X$	$(u\bar{d})/(u\bar{u}) \rightarrow \gamma^*$	\bar{d}/\bar{u}	$0.015 \lesssim x \lesssim 0.35$
$\nu(\bar{\nu}) N \rightarrow \mu^-(\mu^+) X$	$W^* q \rightarrow q'$	q, \bar{q}	$0.01 \lesssim x \lesssim 0.5$
$\nu N \rightarrow \mu^- \mu^+ X$	$W^* s \rightarrow c$	s	$0.01 \lesssim x \lesssim 0.2$
$\bar{\nu} N \rightarrow \mu^+ \mu^- X$	$W^* \bar{s} \rightarrow \bar{c}$	\bar{s}	$0.01 \lesssim x \lesssim 0.2$
$e^\pm p \rightarrow e^\pm X$	$\gamma^* q \rightarrow q$	g, q, \bar{q}	$0.0001 \lesssim x \lesssim 0.1$
$e^+ p \rightarrow \bar{\nu} X$	$W^+ \{d, s\} \rightarrow \{u, c\}$	d, s	$x \gtrsim 0.01$
$e^\pm p \rightarrow e^\pm c\bar{c} X$	$\gamma^* c \rightarrow c, \gamma^* g \rightarrow c\bar{c}$	c, g	$0.0001 \lesssim x \lesssim 0.01$
$e^\pm p \rightarrow \text{jet} + X$	$\gamma^* g \rightarrow q\bar{q}$	g	$0.01 \lesssim x \lesssim 0.1$
$p\bar{p} \rightarrow \text{jet} + X$	$gg, qq, q\bar{q} \rightarrow 2j$	g, q	$0.01 \lesssim x \lesssim 0.5$
$p\bar{p} \rightarrow (W^\pm \rightarrow \ell^\pm \nu) X$	$ud \rightarrow W, \bar{u}\bar{d} \rightarrow W$	u, d, \bar{u}, \bar{d}	$x \gtrsim 0.05$
$p\bar{p} \rightarrow (Z \rightarrow \ell^+ \ell^-) X$	$uu, dd \rightarrow Z$	d	$x \gtrsim 0.05$

- The key role of hadronic collision data to determine the unpolarized PDFs of the proton has long been exploited
- RHIC provides equally critical data to determine polarized PDFs
 - Have provided essential constraints on gluon and anti-quark polarizations
 - Now also providing critical insights in transverse spin phenomena

RHIC: the Relativistic Heavy Ion Collider



- Search for and study the Quark-Gluon Plasma
- **Explore the partonic structure of the proton**
- **Determine the partonic structure of nuclei**

RHIC: the world's first (and only!) polarized hadron collider

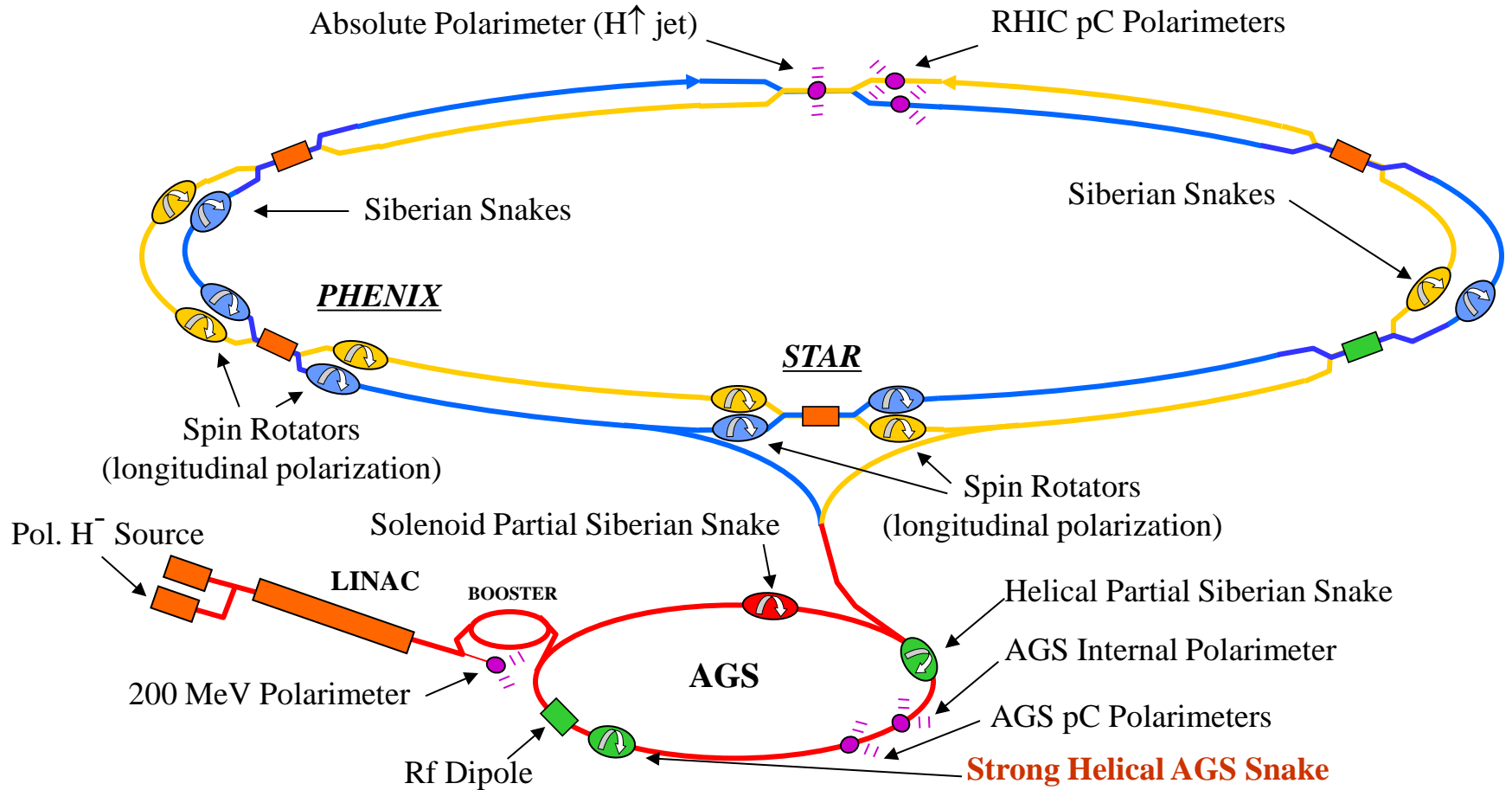

- Spin varies from rf bucket to rf bucket (9.38 MHz)
- Spin pattern changes from fill to fill
- Spin rotators provide choice of spin orientation
- Billions of spin reversals during a fill with little depolarization

FMS

$2.6 < \eta < 4$
Full azimuth

Magnet

BEMC

TPC

TOF

BBC

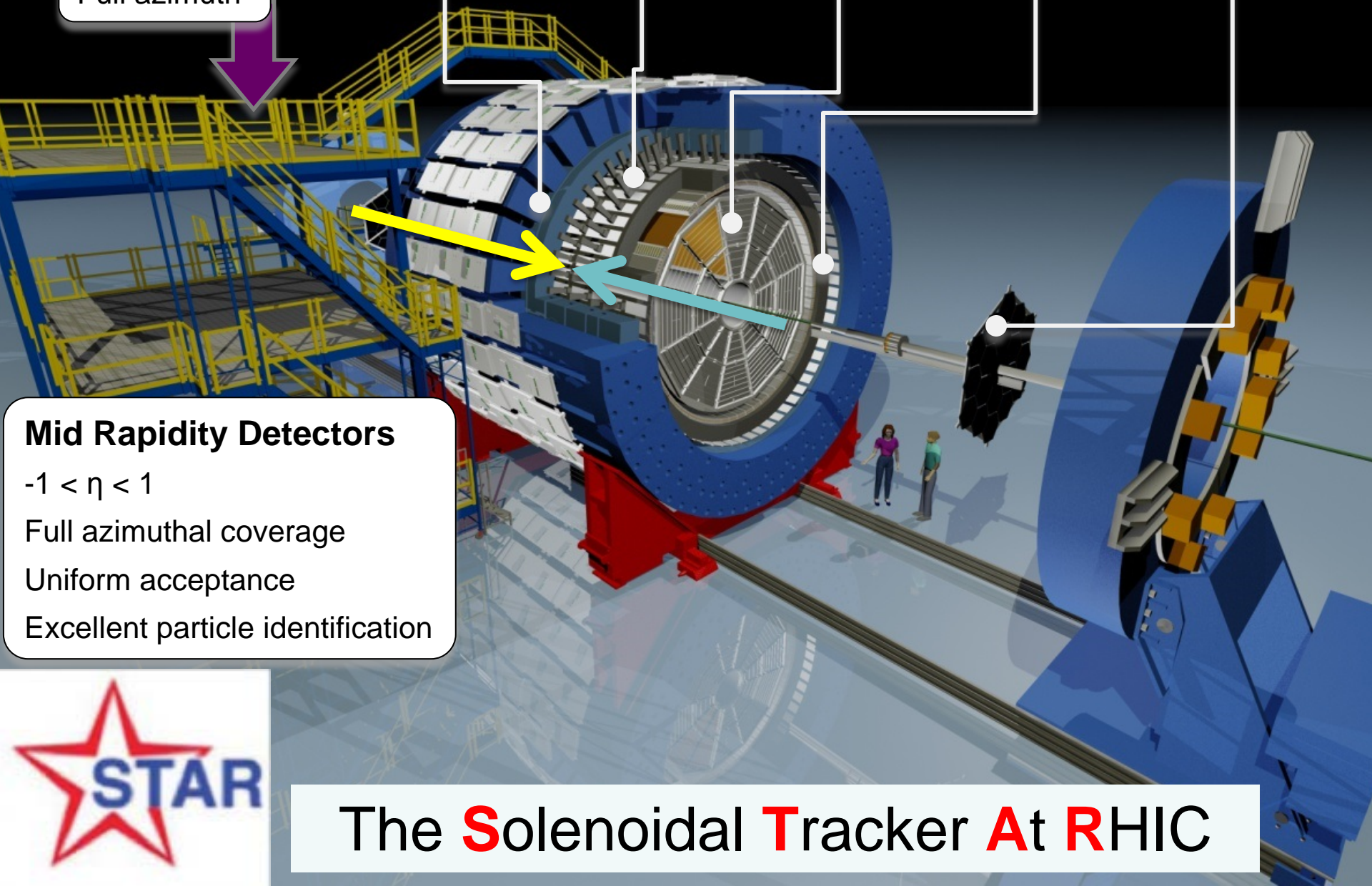

Mid Rapidity Detectors

$-1 < \eta < 1$

Full azimuthal coverage

Uniform acceptance

Excellent particle identification



The **S**olenoidal **T**racker **A**t **R**HIC

Recent transverse spin measurements

Initial state: TMDs and Twist-3

TMD

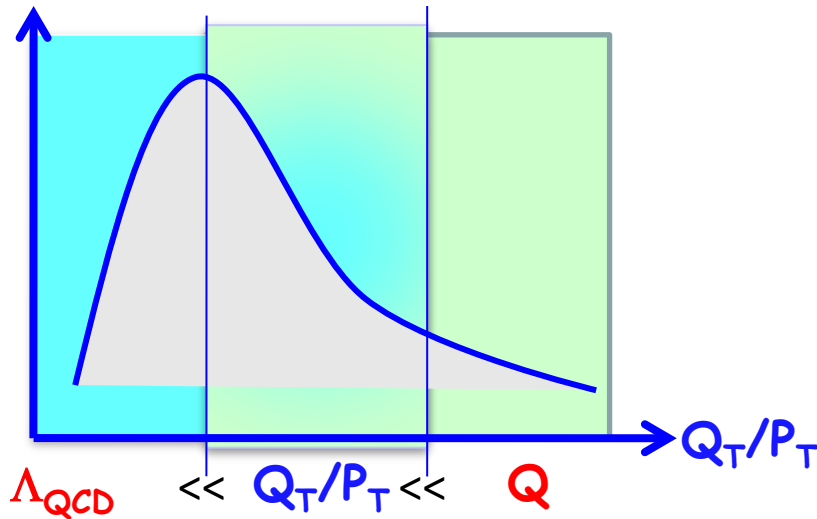
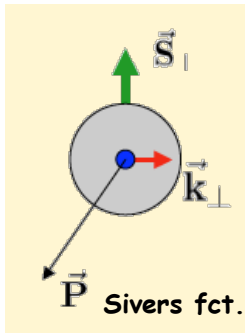

Twist-3

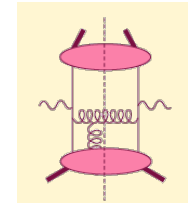

Efremov, Teryaev;
Qiu, Serman
or
Twist-3 FF

Requires 2 scales:

Hard scale Q^2

Soft scale p_T

SIDIS, Drell-Yan, W/Z, ...

Access the full transverse momentum dynamics k_T

Single hard scale: p_T

Appropriate for inclusive $A_N(\pi^0, \gamma, \text{jet})$

Access the average transverse momentum $\langle k_T \rangle$

$$-\int d^2 k_{\perp} \frac{k_{\perp}^2}{M} f_{1T}^{\perp q}(x, k_{\perp}^2)|_{SIDIS} = T_{q,F}(x, x)$$

Color interactions in QCD

Controlled non-universality of the Sivers function

QCD:

DIS
Final-state interaction
Opposite colors attract

Drell-Yan, W or Z
Initial-state interaction
Like colors repel

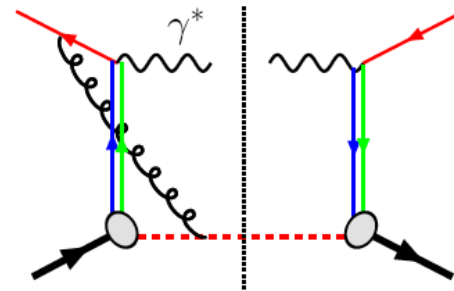
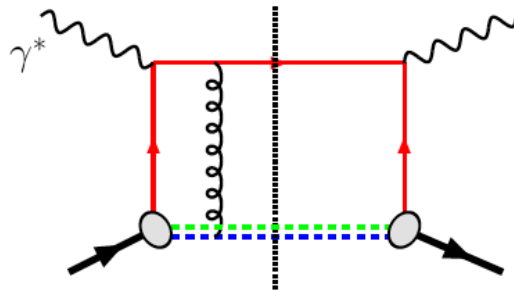

$$\text{Sivers}_{\text{DIS}} = - \text{Sivers}_{\text{Drell-Yan}} \text{ or } \text{Sivers}_W \text{ or } \text{Sivers}_Z$$

A_N for direct photon has related sign change in Twist-3

Critical test of factorization

**Opportunity to visualize the repulsive interaction
between like color charges**

**Can explore all of these observables
in 510 GeV pp collisions at RHIC**

A_N for W production



PRL 116, 132301 (2016)

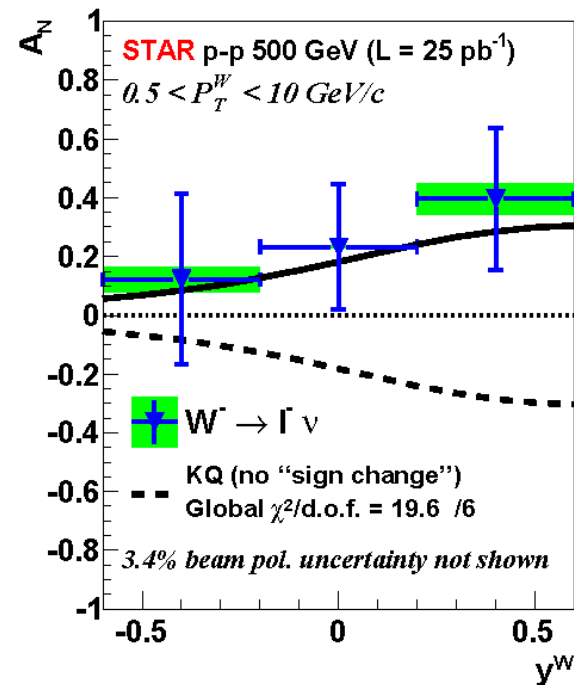
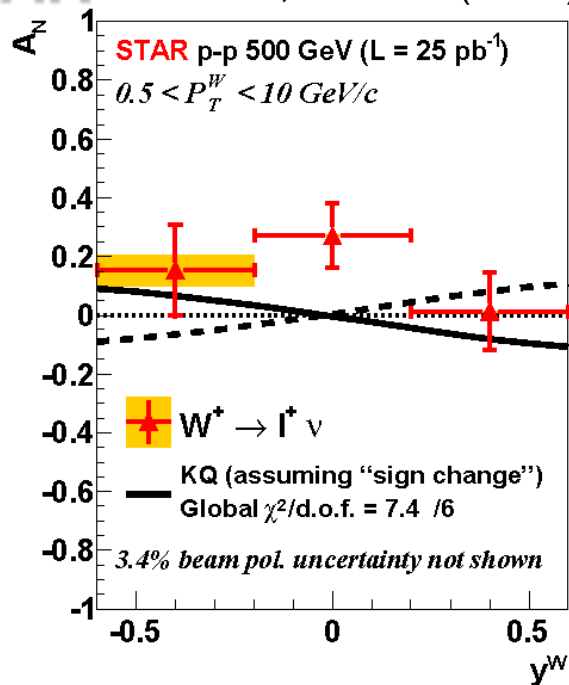

- STAR performed an exploratory measurement of A_N for W production with a small data set recorded in 2011
 - W kinematics fully reconstructed
- Favors **sign change** if evolution effects are modest
 - TMD evolution is non-perturbative at low k_T – no absolute theory predictions

Definitive measurement

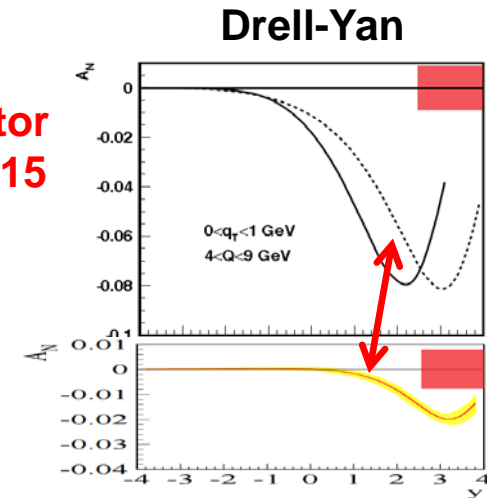
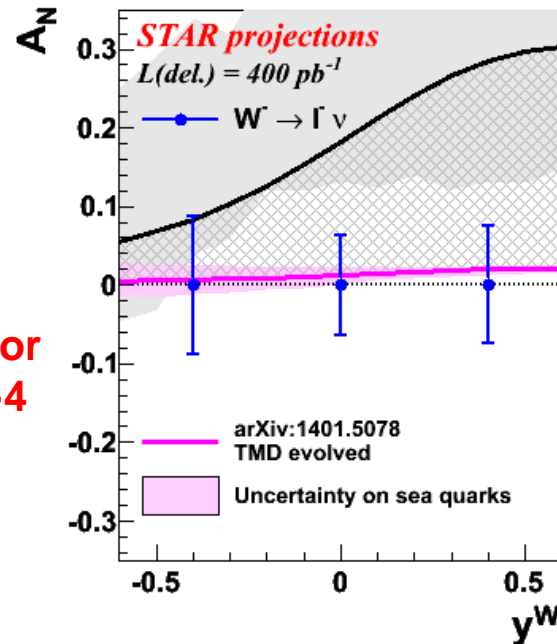
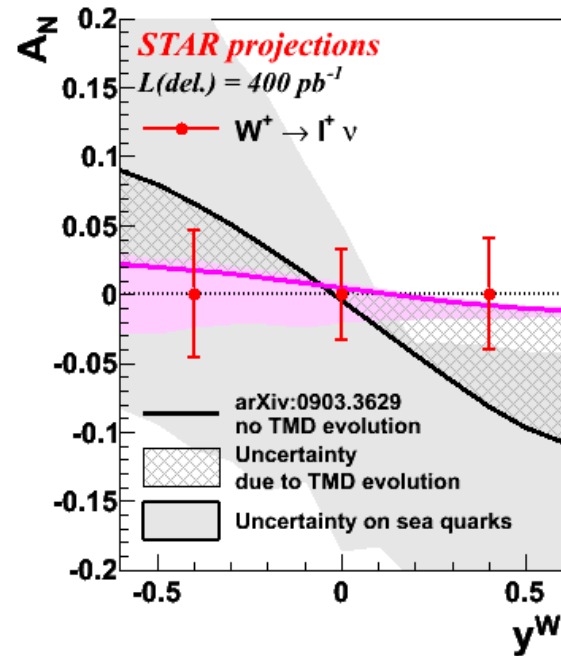

- See the sign change if evolution effects are less than factor of 5
 - Probe anti-quark Sivers function for the first time
 - Directly measure the evolution effects
 - Need new data to constrain non-perturbative contribution
 - Access similar observables at comparable x but very different Q^2
 - W and Z A_N at 510 GeV
 - Drell-Yan at 510 GeV
- 2017 RHIC run, data currently under analysis**

Definitive measurement

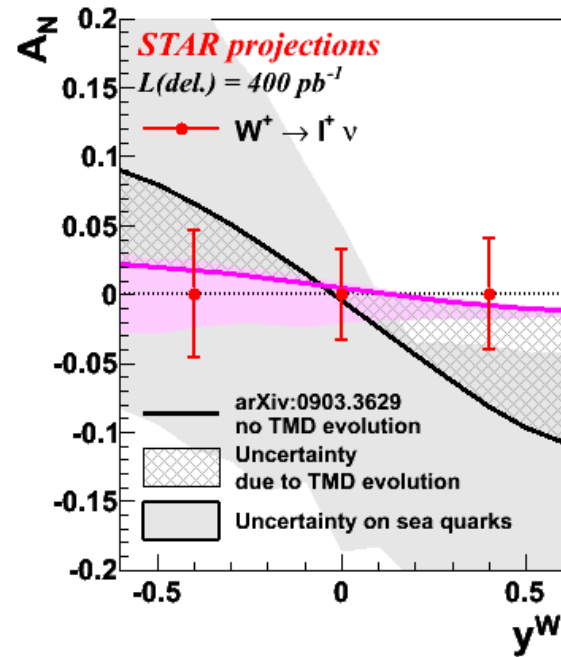

Factor of ~4

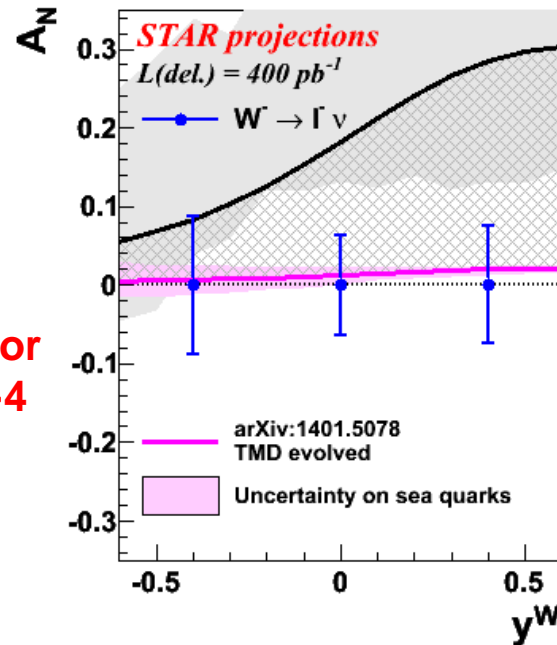

Factor of ~15

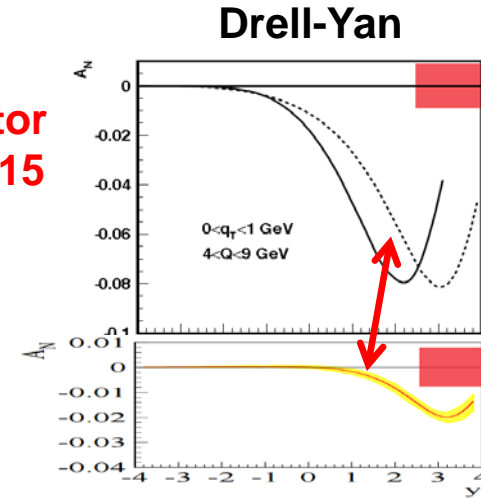

Factor of ~4

- See the sign change if evolution effects are less than factor of 5

Propose a return to 510 GeV in 2021:

Go beyond testing the sign

Are the magnitudes *really equal* in SIDIS and pp collisions?

— ACCESS similar observables at comparable x but very different Q^2

- W and Z A_N at 510 GeV
- Drell-Yan at 510 GeV

2017 RHIC run, data currently under analysis

A_N for direct photon

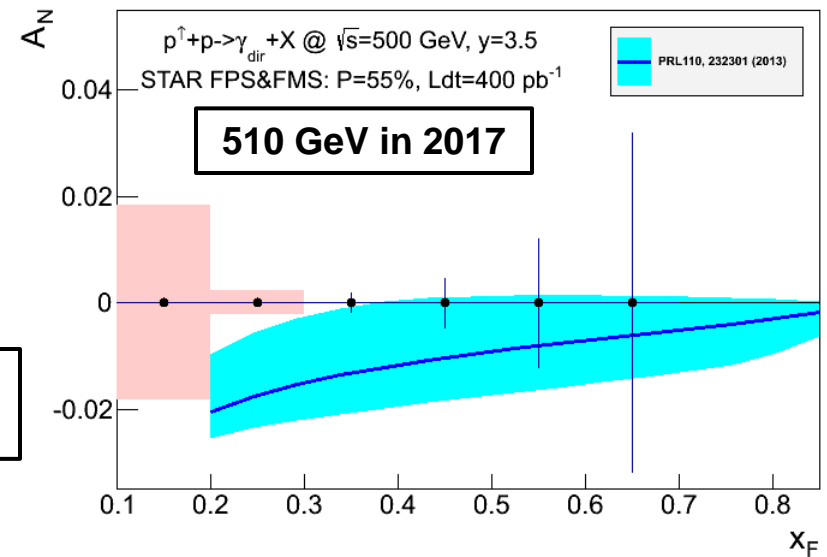
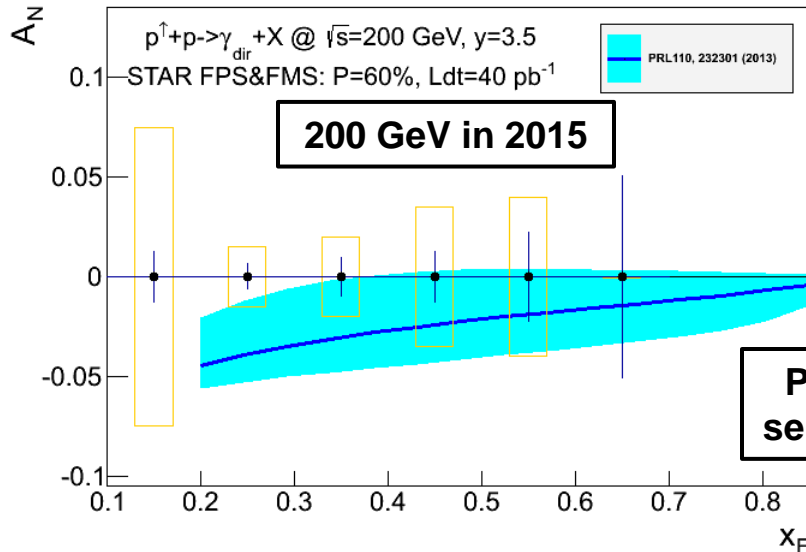

- Sensitive to the sign change in the Twist-3 formalism
- Collinear objects, but more complicated evolution than DGLAP
 - Not sensitive to TMD evolution
- Provides an indirect constraint on the Sivers function via their integral relationship

Not a replacement for $A_N(W, Z, DY)$, but an **important complementary piece of the puzzle**

A_N for direct photon

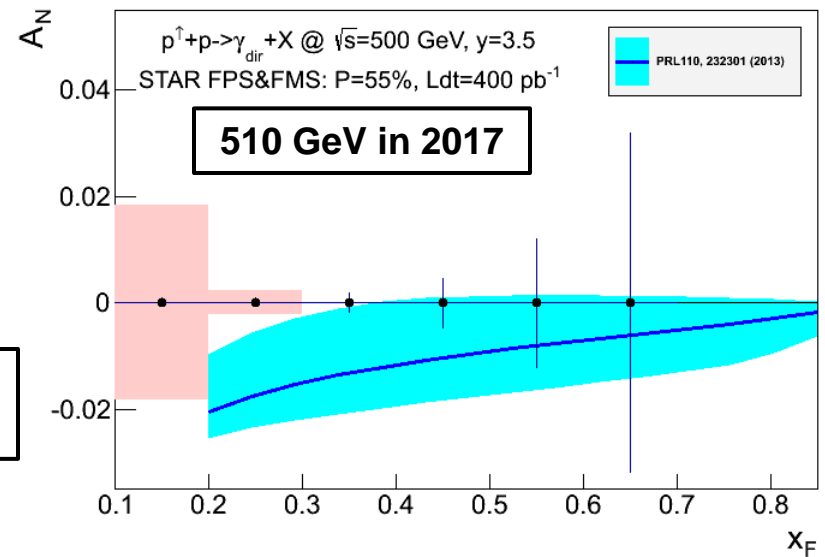
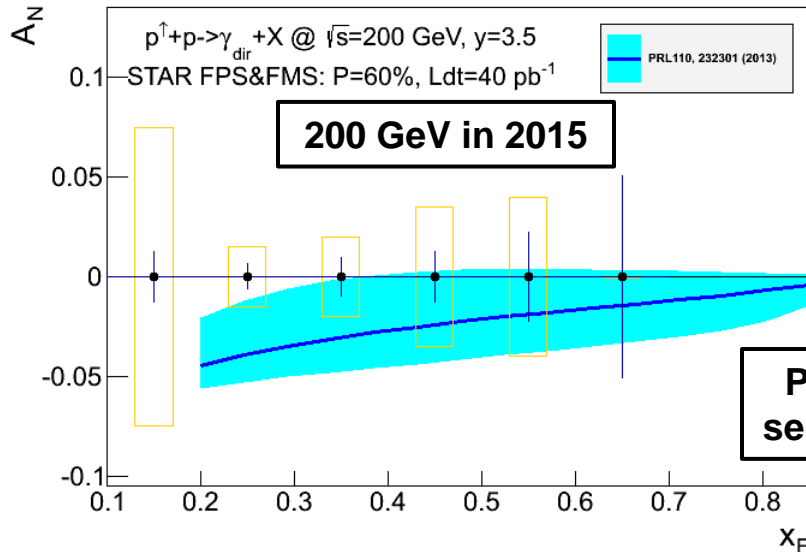

- Sensitive to the sign change in the Twist-3 formalism
- Collinear objects, but more complicated evolution than DGLAP
 - Not sensitive to TMD evolution

- Provide integrals

Expect to return to 200 GeV in 2023:
 Reduce 200 GeV uncertainties by ~ 3
 Precision measurement of Twist-3 evolution

important complementary piece of the puzzle

Transversity

Proton momentum \rightarrow
Proton spin \uparrow

$\delta q(x)$
 $\Delta_T q(x)$

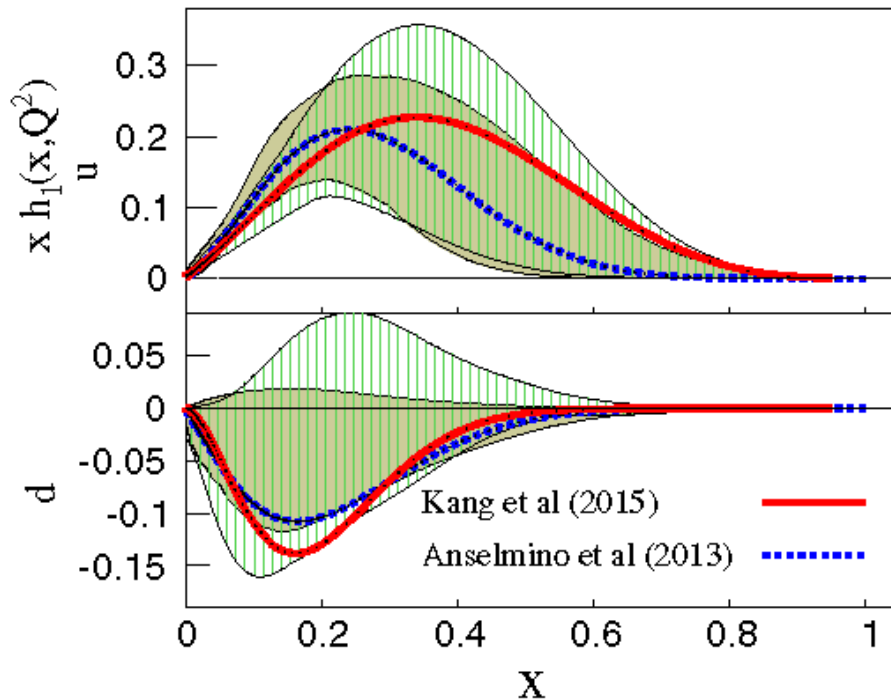
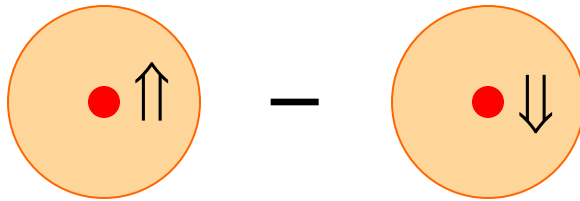

- Quark polarization along spin of a transversely polarized proton
 - Third collinear, leading twist distribution
 - Chiral odd
- Much less data than for helicity
- Before **STAR**, only observed in SIDIS combined with e^+e^-
- Several recent global analyses including:
 - Collins effect SIDIS input:
 - PRD 93, 014009 (2016)
 - PRD 92, 114023 (2015)
 - IFF SIDIS + **STAR** pp input:
 - PRL 120, 192001 (2018)
 - All show large uncertainties

First transversity signals in hadronic collisions

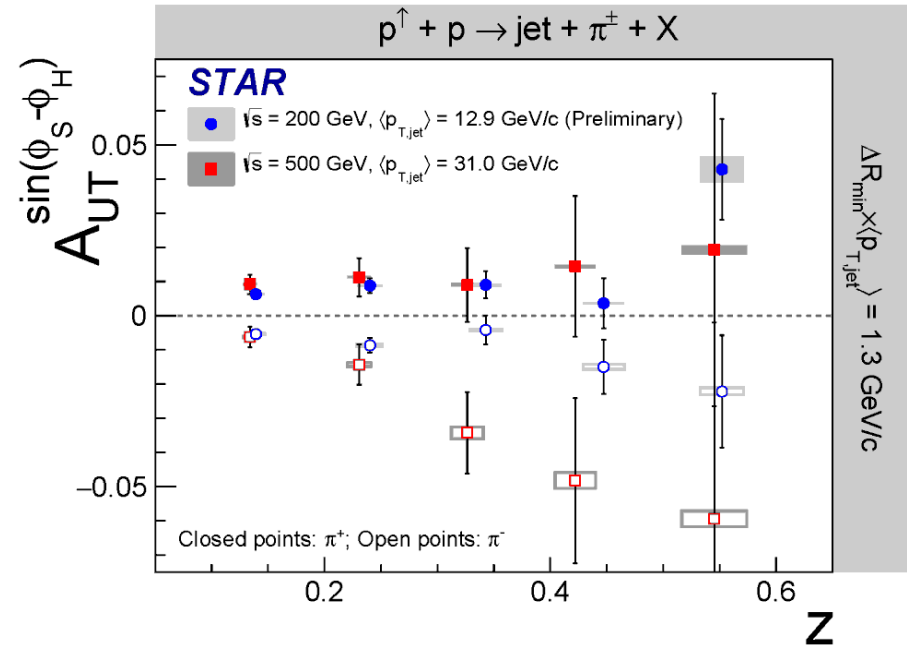
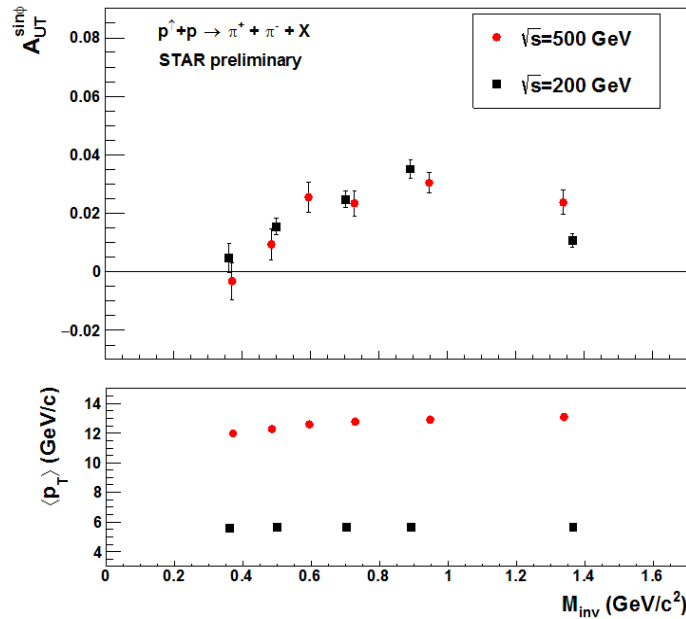

- Significant measurements of transversity convoluted with:
 - Di-hadron interference fragmentation function (IFF)
 - Collins fragmentation function
- Both have similar magnitudes in 200 and 500 GeV pp collisions
- Complementary results that obey different evolution equations

$x - Q^2$ coverage for IFF and Collins effect



PLB 780, 332 (2018)

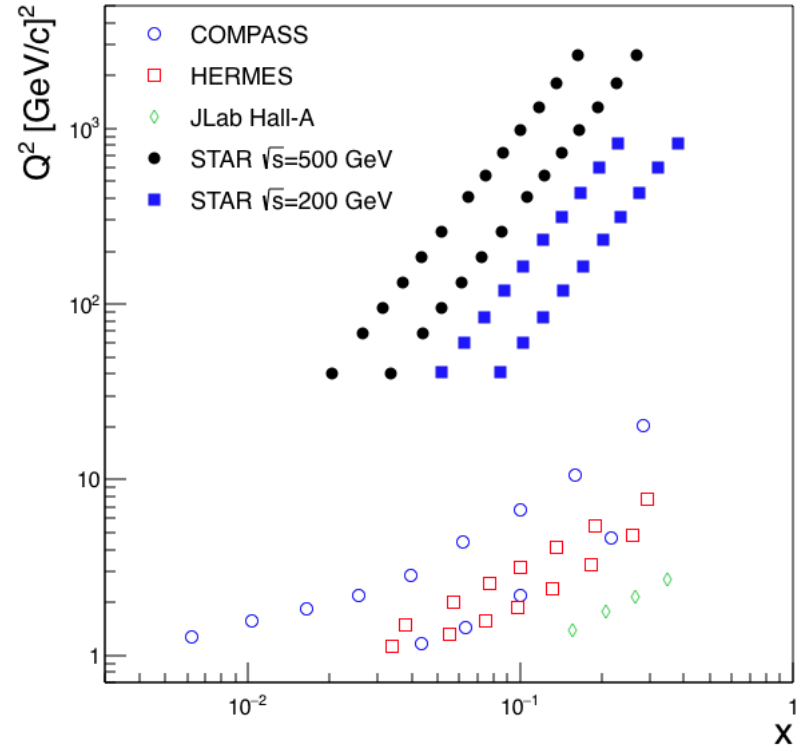
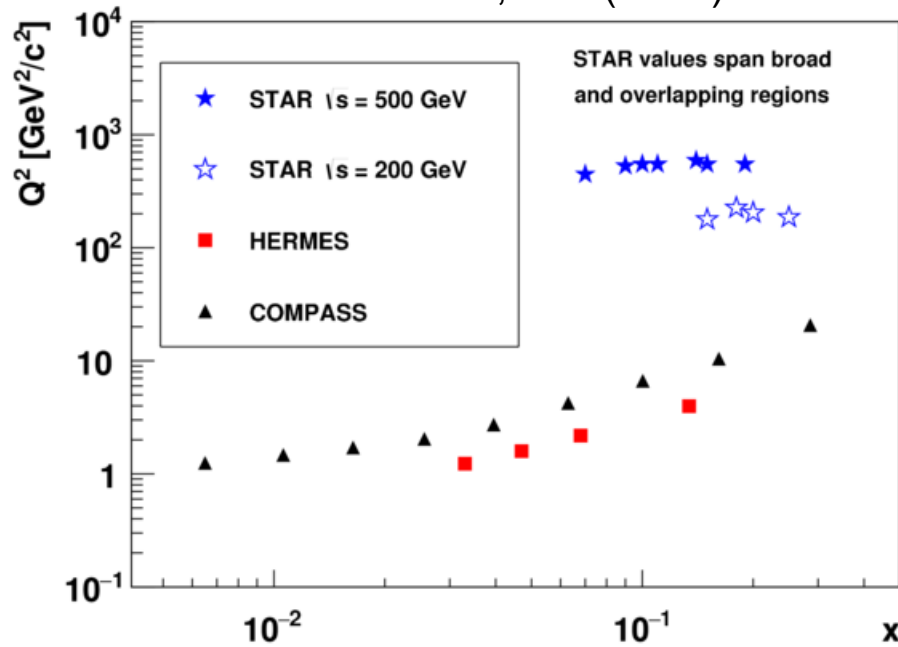

- STAR measurements provide the first observations of transversity at very high scales
 - One to two orders of magnitude higher than all previous measurements

STAR IFF and global analysis

 **STAR** PLB 780, 332 (2018)

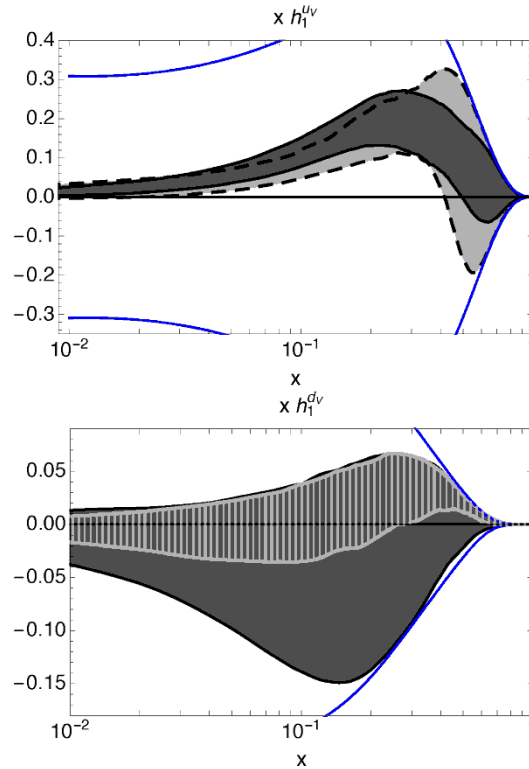
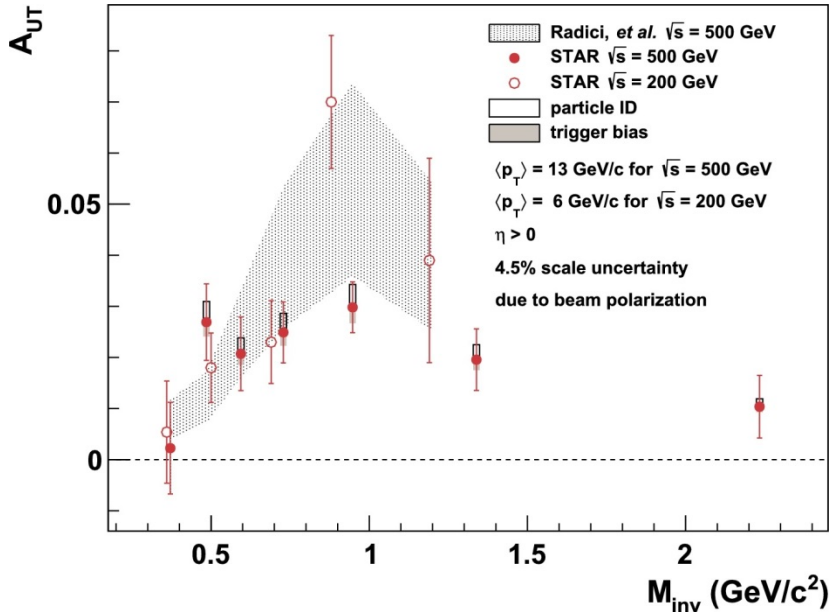

Radici and Bacchetta, PRL 120, 192001 (2018)

- **STAR** IFF measurements in 200 and 500 GeV pp collisions are well described by recent IFF calculations
- Radici and Bacchetta have performed a global analysis including the **STAR** IFF results from 200 GeV pp collisions [PRL 115, 242501 (2015)]
 - **STAR** data significantly reduce the uncertainty for h_1^{u-val}
 - $g \rightarrow \pi^+ \pi^-$ FF dominates the uncertainty for h_1^{d-val}

$\pi^{+/-}$ azimuthal distribution in jets

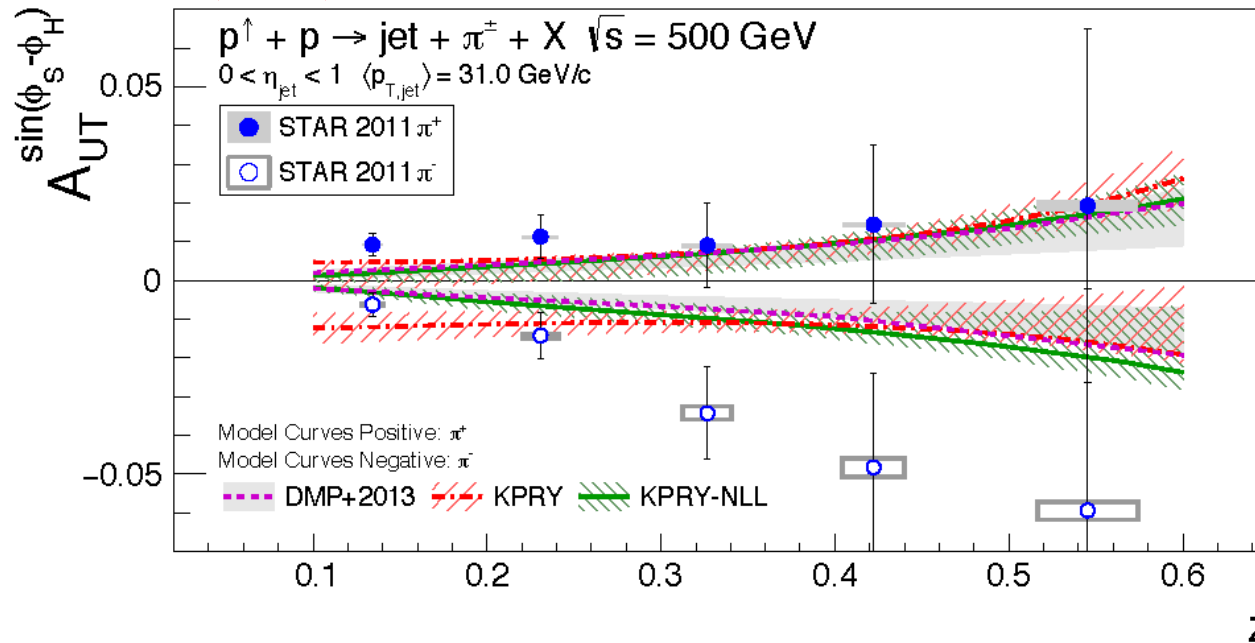
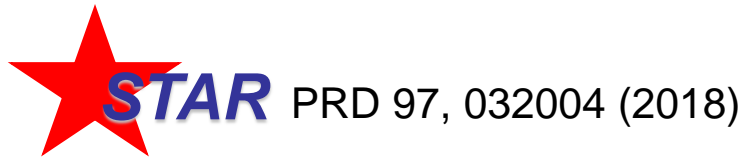

DMP: PLB 773, 300 (2017)
KPRY: PLB 774, 635 (2017)

- First Collins effect measurements in pp collisions are reasonably described by two recent calculations that convolute the transversity distribution from SIDIS with the Collins FF from e^+e^- collisions
 - Tests the predicted **universality of the Collins FF**
 - Kang et al, JHEP 11, 068 (2017)
 - TMD evolution effects appear to be small

Collins effect vs. j_T in separate z bins

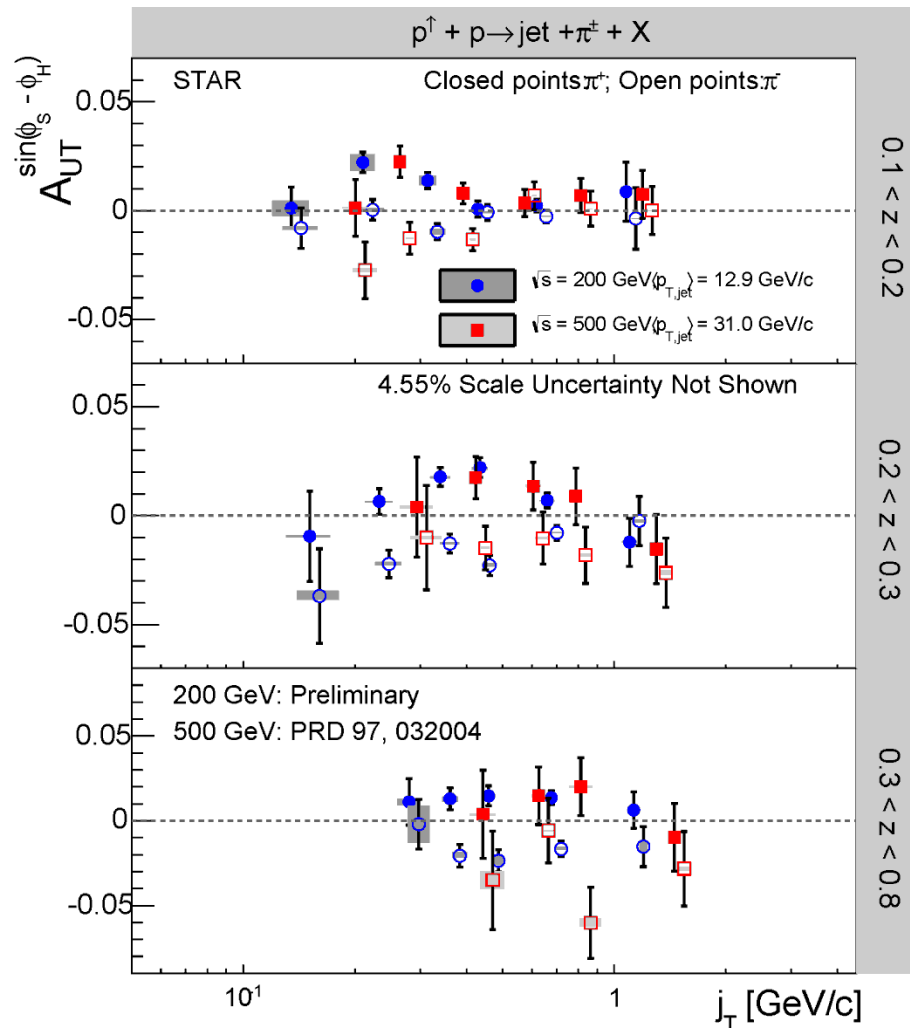

- 500 GeV pp results hinted the A_{UT} peak shifts to higher j_T as z increases
- New preliminary **200 GeV pp results provide confirming evidence**

Additional modulations: “Collins-like” effect



500 GeV: PRD 97, 032004 (2018)

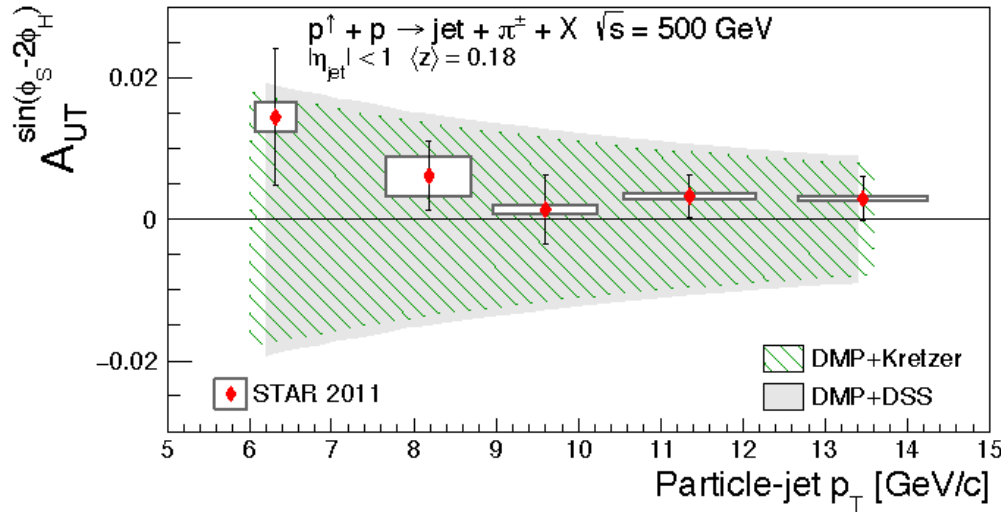

200 GeV: Preliminary

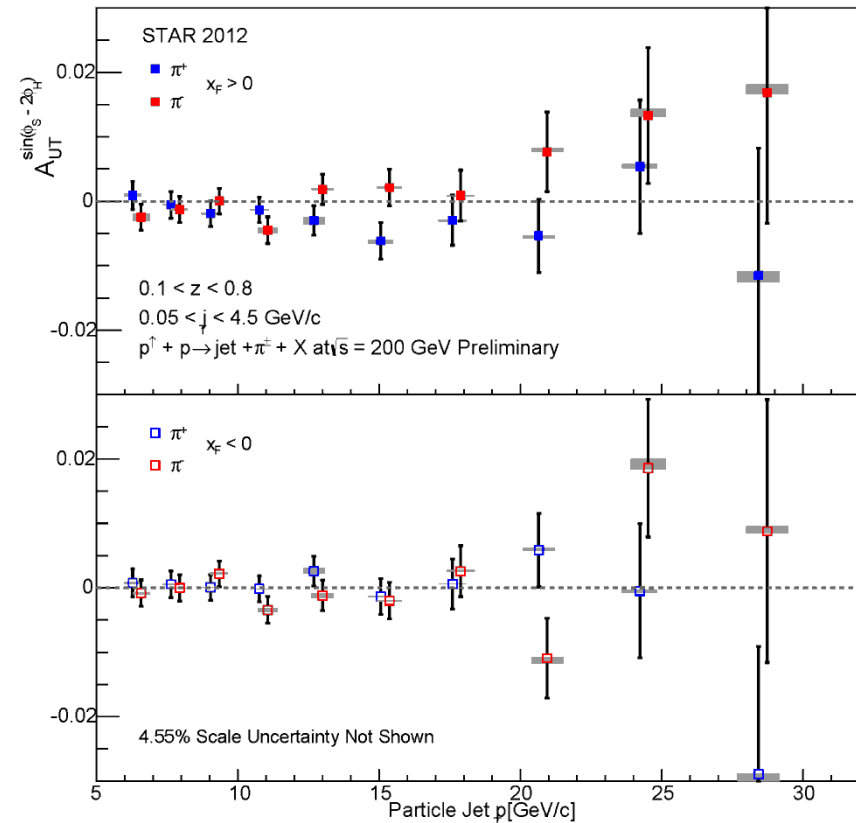

- Collins-like effect
 - **World’s first ever limit** on linearly polarized gluons in a polarized proton
 - New preliminary results from 200 GeV pp collisions
 - Will provide much stronger limits

Additional modulations: inclusive jet A_N



500 GeV: PRD 97, 032004 (2018)

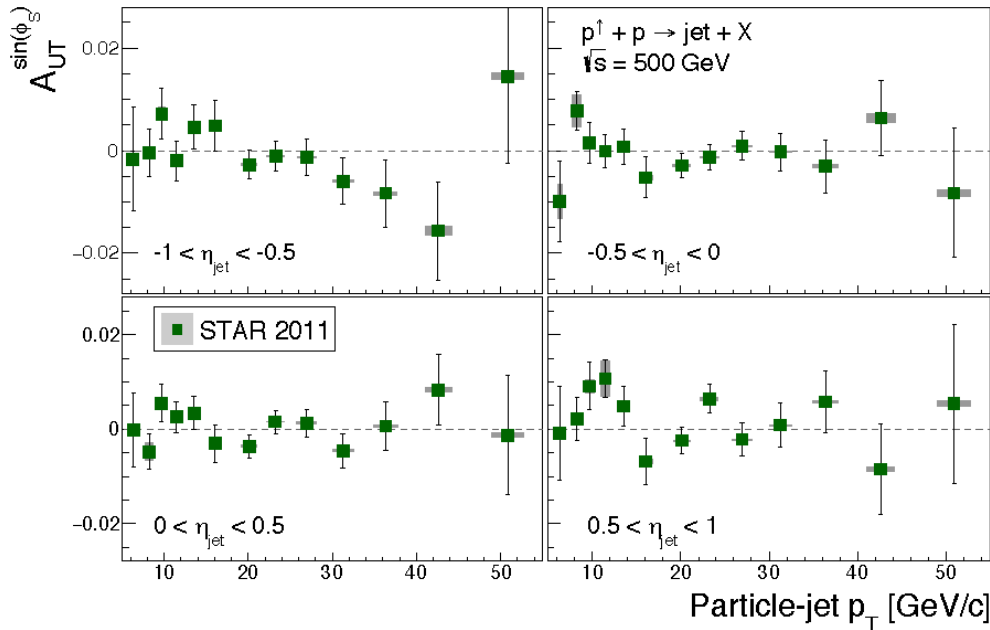

200 GeV: Preliminary

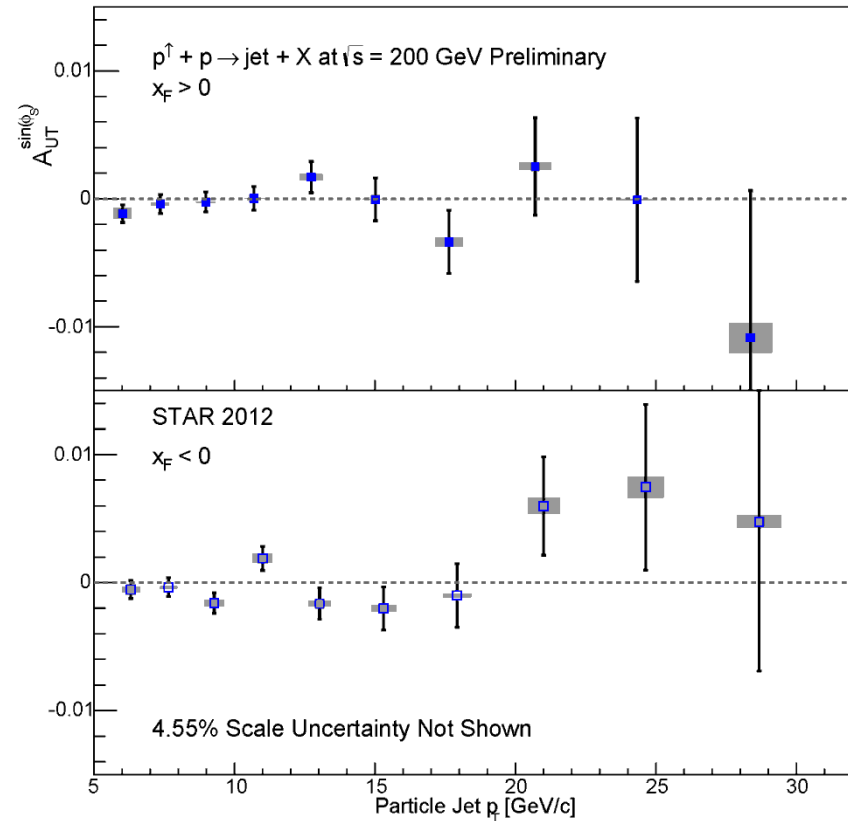

- Inclusive jet A_N
 - Sensitive to the gluon Sivers function via the Twist-3 relationship
 - New preliminary results in 200 GeV pp collisions
 - Far more precise than 500 GeV results
 - Still consistent with zero

Projected uncertainties for upcoming results

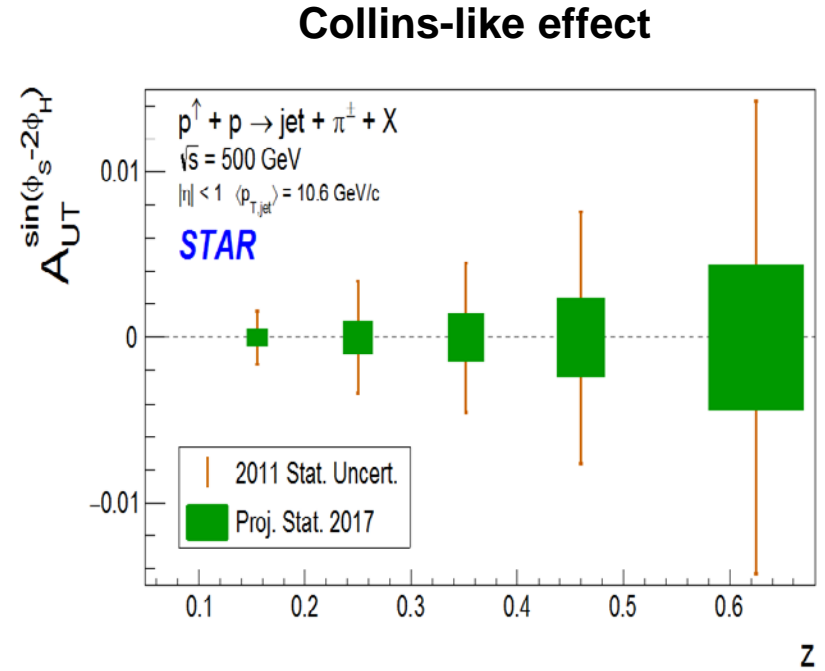
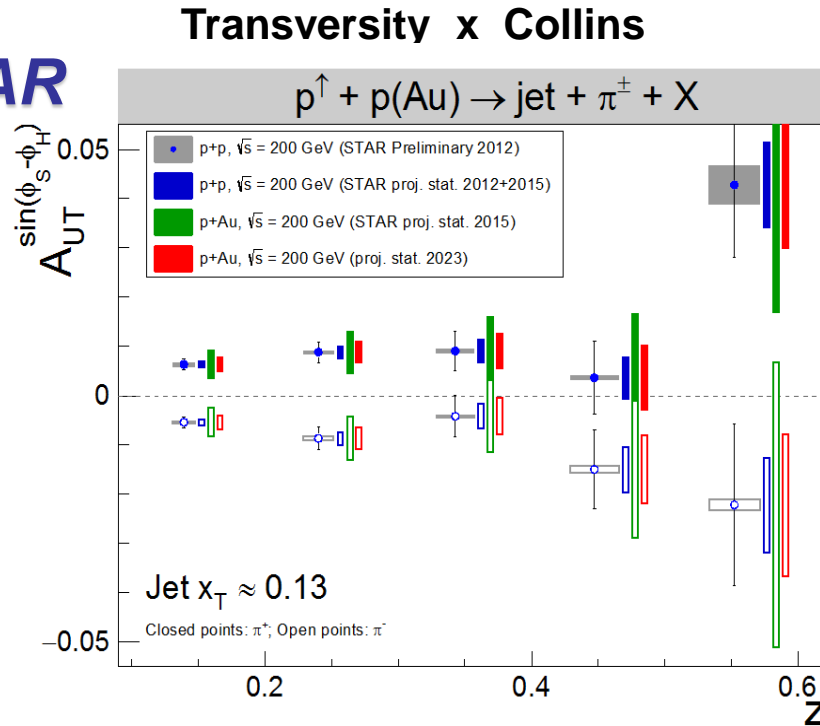

- Final Collins results from 2012 200 GeV run will be coming soon
 - 200 GeV data from 2015, with twice the FoM, under analysis
- Recorded > 10 times as much data at 510 GeV in 2017 as in 2011
 - Precision data at fixed x , different \sqrt{s} **ideal to constrain TMD evolution**
- Also have data for a first look at the **Collins effect in p+Au collisions**

STAR Forward Upgrade plans

For a more detailed discussion, see:

The STAR Forward Rapidity Upgrade

Ken Barish (sub for Elke Aschenauer)

Future Facilities and Experiments, Wed, 17:40

Planned forward upgrade for the 2020's

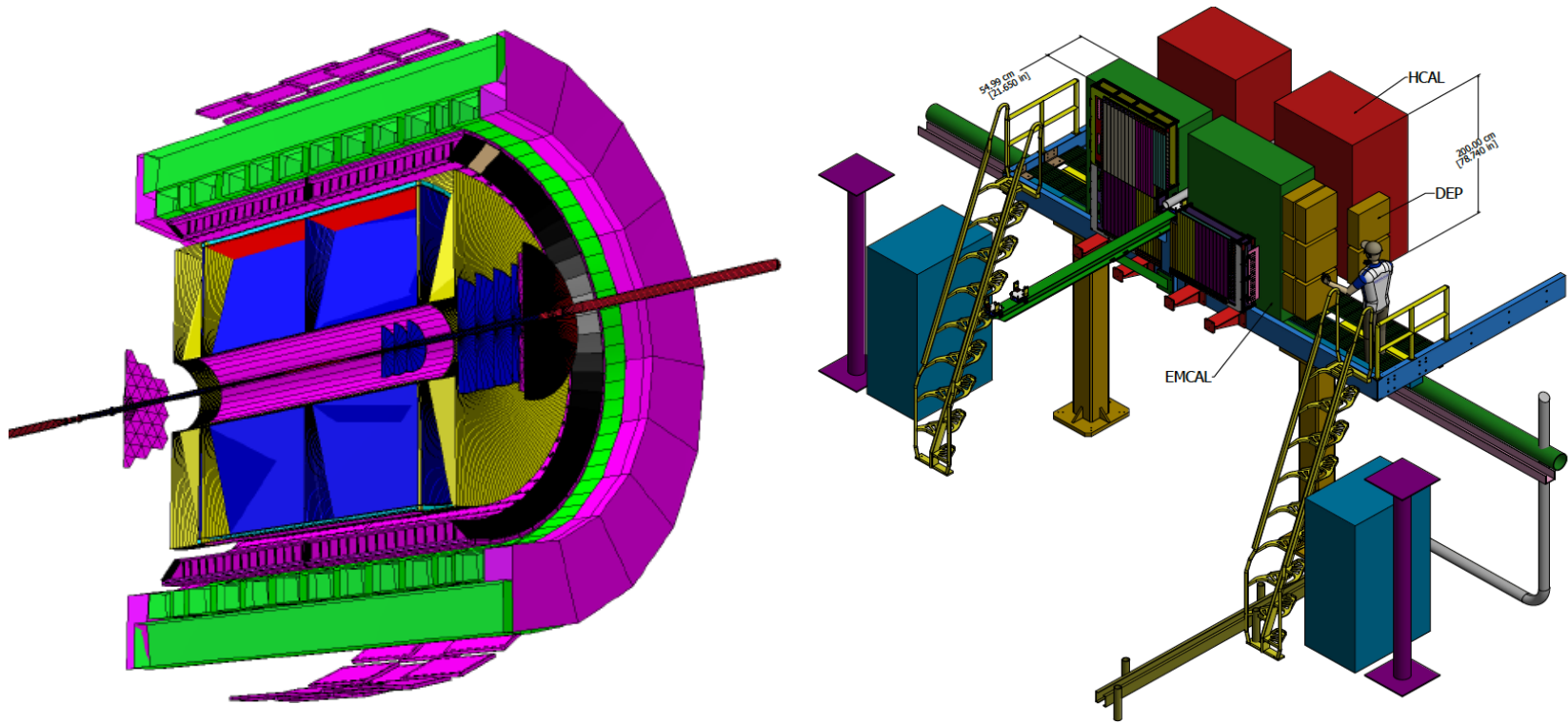

- Si disks + small Thin Gap Chambers for tracking
- Compact electromagnetic and hadronic calorimeters
- Transverse spin phenomena:
 - Precision TMDs through jets at forward rapidity
 - Precision A_N (Drell-Yan) to complete the Sivers measurements

Sivers and Collins coverage at RHIC

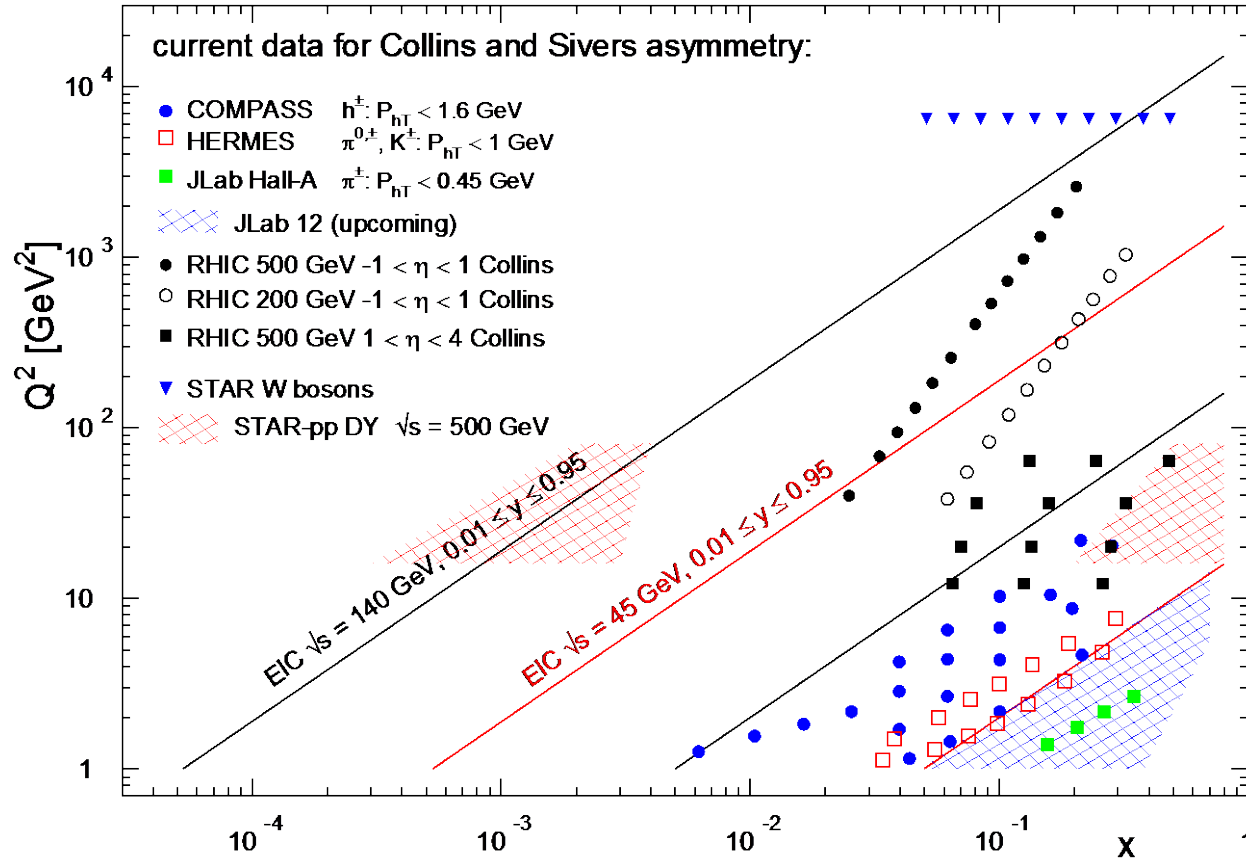

- Kinematics of RHIC

- Dramatic extension in (x, Q^2) reach before EIC
- W production probes the highest Q^2 over a wide x range
- **Precision tests of universality** when EIC data become available

Conclusions

- The **STAR** transverse spin program has made a number of striking observations
- **STAR** has a huge body of additional spin data under analysis
- The **STAR Forward Upgrade** will provide a bright future for **STAR** in the coming decade
- **STAR** is a key component of the **RHIC Cold QCD program**: an essential bridge between the physics of RHIC and the physics of the future Electron Ion Collider